

FITTINGS



Clamp Fittings



CLAMP FITTINGS....

Clamp Style Fittings are most popular for easy assembly and breakdown of process lines and equipment. VNE offers Clamp Fittings in T304 and T316L materials in 1/2" through 12" sizes.

Gaskets for Clamp Fittings are available in several different materials, Buna-N, EPDM, Teflon®, and Viton®. Lightweight and heavy-duty clamps complete the unions. VNE's Clamp Fittings meet all 3A requirements.

CLAMP FITTING SPECIFICATIONS....

Size Range: 1/2" OD through 12" OD

Materials: T304
T316L

Finish: No. 7 - ID & OD
No. 5 - OD only
No. 3 - ID only
No. 1 - unpolished

ORDERING SPECIFICATIONS....

- Specify:**
- Quantity
 - Product description or Part No.
 - Size
 - Material Type
 - Polish Requirements

LIMITED WARRANTY....

VNE Corporation products are warranted to be free from defects in material and workmanship for a period of one year from the date of shipment. Any product that proves to be defective shall be repaired or replaced at the option of VNE, providing it has been used as recommended and in strict accordance with recognized piping practices, and that has not been subject to extraordinary service, such as encountered under severe corrosive or abrasive conditions.

VNE makes no warranties, express or implied, other than those listed above.

VNE shall not be liable for any consequential, indirect, incidental or contingent damages.

VNE CORPORATION

P.O. Box 1698 • 1149 Barberry Drive • Janesville, WI 53547

TEL: 608-756-4930 • FAX: 608-756-3643 • 1-800-356-1111 • Web site: vnestainless.com

CLAMP TYPE

VNE	TRI-CLOVER	WAUKESHA	G & H	JENSEN
EG2C	2CMP	2CMP	GC2C	JC2
EG2C-31	2CMP-31MP	2CMP-31MP	GC2C-31	JC2-J31
EG2FPR	2FMP-14	2FMP-14	GC2F-14	JC2-14
EG2WU	-----	-----	GC2WU	J2WU
EG2FTR	2FMP-15	2FMP-15	GC2F-15	JC2-15
EG2K	2KMP	2KMP	GC2K	JC2K
EG7	7MP	7MP	GC7	JC7
EG7R	7RMP	7RMP	GC7R	JC7R
EG9	9MP	9MP	GC9	JC9
EG10CC	D10MP	10CMP	GC10C	JC10C
EG10RCC	D10MPR	10CMPR	GC10PC	JC10CR
EG11CC	D11MP	10CMP	GC11C	JC11C
EG11RCC	D11MPR	11CMPR	GC11RC	JC11CR
EG13	13MHLA	-----	GH13FAH	K13LH
13MHHM	13MHHM	13MHHM	GC13LAH	JC13HC
13MHP	13MHP	13MHP	13MHP	JC13HP
EG14HT	14MPHT	14MPHT	GC14AHT	JC14AHT
EG14W	14MPW	14MPW	GC14W	JC14H
EG14WL	14WLMP	14WLMP	GC14WL	JC14
EG14AM7	L14AM7	L14AM7	GC14AC	JC14AM7
EG2CS	14WMP	14WMP	GC2CS	JC14X
14RMP	14RMP	14RMP	GC14R	JC14EX
EG14RT	14MPHR	14MPHR	GC14AHR	JC14AHR
EG16A	16AMP	16AMP	GC16A	JC16
EG17PR	17MP-14	17MP-14	GC17PC	JC17-14
EG17TR	17MP-15	17MP-15	GC17TC	JC17-15
EG21	21MP	21MP	GC21	JC21
EG22	22MP	22MP	GC22	JC22
EG31R	31RMP	31RMP	GC31R	JC31R
EG31CC	31-14MP	31-14MP	GC31CC	JC31
EG32CC	32-14MP	32-14MP	GC32CC	JC32
EG31PC	31PMP	31PMP	GC31PC	J14-C31
EG32PC	32PMP	32PMP	GC32PC	J14-C32
EG31CP	31MPP	31MPP	GC31CP	JC31-14
EG32CP	32MPP	32MPP	GC32CP	JC32-14
EG31TC	31TMP	31TMP	GC31TC	J15-C31
EG32TC	32TMP	32TMP	GC32TC	J15-C32
EG31CT	31MPT	31MPT	GC31CT	JC31-15
EG32CT	32MPT	32MPT	GC32CT	JC32-15
EG40	40MPU	40MPU	GC40	JC40N
EG40T	40MPG	40MPG	GC40T	JC40T
EG45BY	45BYMP	45BYMP	GC45SH	-----
EG45CC	B45MP	45HMP	-----	45HC
EG23B	23BMP	23BMP	GC23B	JC23B
EG28A	28AMP	28AMP	GC28A	JC28A
EG28B	28BMP	28BMP	GC28B	JC28B

CLAMP FITTINGS

EG2C - 90° ELBOW

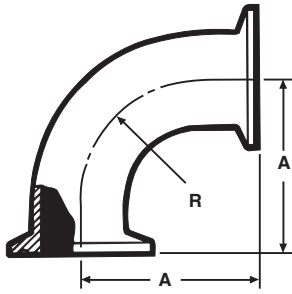

Size Tube OD	T304	T316L
1	\$28.30	\$38.67
1 1/2	\$28.56	\$39.67
2	\$38.33	\$52.00
2 1/2	\$52.30	\$74.00
3	\$60.50	\$102.34
4	\$123.00	\$155.56
6	\$666.67	\$777.78
8	\$1,391.12	\$1,546.92

EG2WU - CLAMP 180° U-BEND

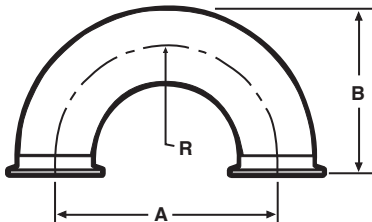

Size Tube OD	T304	T316L
1/2	T316L	\$577.78
3/4	T316L	\$577.78
1	\$233.34	\$205.56
1 1/4	POA	POA
1 1/2	\$233.33	\$328.89
2	\$286.67	\$337.78
2 1/2	\$326.67	\$355.56
3	\$371.11	\$511.11
4	\$546.67	\$688.89
6	\$1,500.00	\$1,677.78

EG2FPR - 90° ELBOW

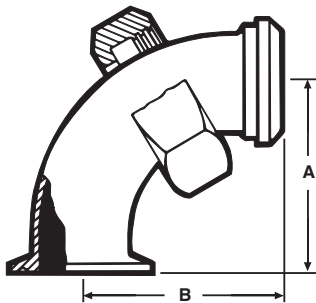

Size Tube OD	T304	T316L
1	\$90.22	\$117.78
1 1/2	\$90.22	\$136.67
2	\$120.00	\$194.44
2 1/2	\$170.22	\$271.11
3	\$222.22	\$355.56
4	\$366.67	\$423.33

EG2FTR - 90° ELBOW

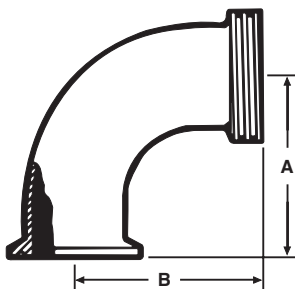

Size Tube OD	T304	T316L
1	\$82.22	\$109.67
1 1/2	\$71.22	\$95.00
2	\$95.22	\$141.78
2 1/2	\$131.11	\$174.89
3	\$148.78	\$198.44
4	\$223.78	\$344.44

EG2C-31CC - 90° REDUCING ELBOW (Non-Tapered)

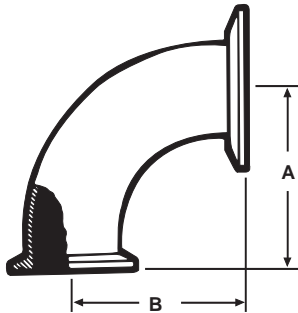

Size Tube OD	T304	T316L
2 X 1	\$124.51	\$193.33
2 X 1 1/2	\$120.89	\$155.22
2 1/2 X 1 1/2	\$133.22	\$209.98
2 1/2 X 2	\$146.10	\$277.38
3 X 1 1/2	\$177.78	\$284.44
3 X 2	\$170.67	\$222.22
3 X 2 1/2	\$170.67	\$311.11
4 X 2 1/2	\$368.89	\$373.33
4 X 3	\$385.56	\$652.22
6 X 4	\$444.44	\$688.89

EG231-FPR 90° REDUCING ELBOW (Non-Tapered)

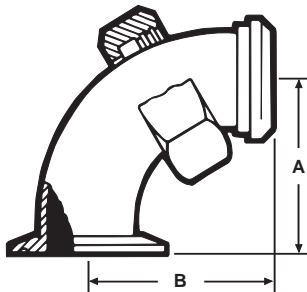

Size Tube OD	T304	T316L
2 X 1	\$221.89	\$226.44
2 X 1 1/2	\$216.26	\$222.22
2 1/2 X 1 1/2	\$244.44	\$256.67
2 1/2 X 2	\$248.89	\$266.22
3 X 1 1/2	\$237.78	\$246.67
3 X 2	\$255.71	\$288.89
3 X 2 1/2	\$271.11	\$333.89
4 X 2 1/2	\$307.29	\$374.00
4 X 3	\$322.22	\$442.22

EG2C-31PR - 90° REDUCING ELBOW (Non-Tapered)

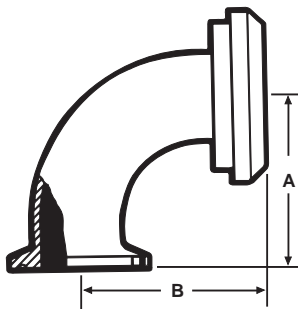

Size Tube OD	T304	T316L
2 X 1	\$221.89	\$226.44
2 X 1 1/2	\$216.26	\$222.22
2 1/2 X 1 1/2	\$244.44	\$256.67
2 1/2 X 2	\$248.89	\$266.22
3 X 1 1/2	\$237.78	\$246.67
3 X 2	\$255.71	\$288.89
3 X 2 1/2	\$271.11	\$333.89
4 X 2 1/2	\$307.29	\$374.00
4 X 3	\$322.22	\$442.22

EG2K - 45° ELBOW

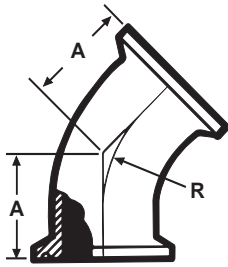

Size Tube OD	T304	T316L
1	\$30.22	\$46.00
1 1/2	\$30.22	\$50.20
2	\$37.11	\$58.67
2 1/2	\$51.12	\$77.78
3	\$67.00	\$113.34
4	\$112.89	\$143.89
6	\$500.00	\$611.11
8	\$888.89	\$1,044.44

EG7 - TEE

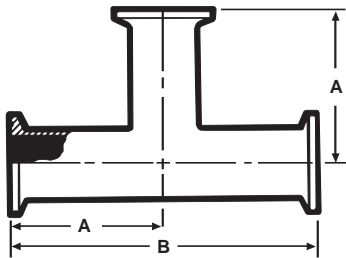

Size Tube OD	T304	T316L
1	\$52.00	\$80.00
1 1/2	\$51.78	\$71.00
2	\$58.89	\$82.00
2 1/2	\$79.11	\$107.11
3	\$112.49	\$153.89
4	\$160.84	\$221.29
6	\$1,111.11	\$1,333.33
8	\$1,733.34	\$1,888.89

EG7R - REDUCING TEE

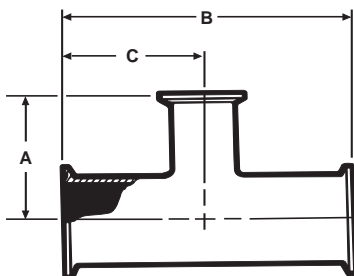

Size Tube OD	T304	T316L
1 1/2 X 1	\$184.22	\$186.67
2 X 1	\$146.67	\$200.00
2 X 1 1/2	\$95.78	\$193.33
2 1/2 X 1 1/2	\$185.78	\$282.22
2 1/2 X 2	\$121.00	\$209.11
3 X 1 1/2	\$308.89	\$408.89
3 X 2	\$147.58	\$216.29
3 X 2 1/2	\$160.09	\$242.22
4 X 2	\$406.67	\$583.33
4 X 2 1/2	\$388.89	\$433.33
4 X 3	\$253.33	\$337.78
6 X 3	\$711.11	\$848.89
6 X 4	\$711.11	\$988.89

EG9 - CROSS

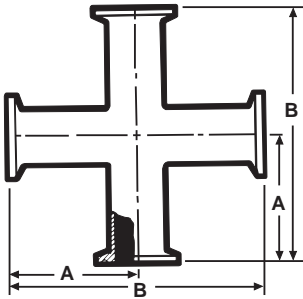

Size Tube OD	T304	T316L
1	\$171.11	\$244.44
1 1/2	\$120.89	\$201.82
2	\$145.04	\$242.80
2 1/2	\$196.56	\$284.84
3	\$245.96	\$395.22
4	\$454.09	\$764.16
6	\$1,555.56	\$1,766.67

EG14AM7 - WELDING FERRULE

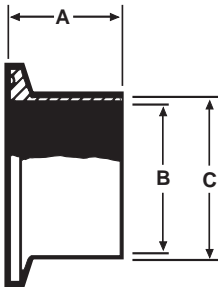

Size Tube OD	T304	T316L
1/2	N/A	\$8.89
3/4	N/A	\$8.89
1	\$6.00	\$8.31
1 1/4	N/A	\$48.89
1 1/2	\$6.00	\$8.31
2	\$7.78	\$9.71
2 1/2	\$10.00	\$16.42
3	\$13.11	\$17.80
4	\$17.73	\$25.47
5	N/A	\$218.44
6	\$108.89	\$110.28
8	N/A	\$384.44
10	N/A	\$566.67
12	N/A	\$811.11

EG14R - RECESSLESS FERRULE (Expanding)

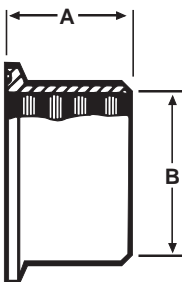

Size Tube OD	T304	T316L
1	\$5.30	\$12.00
1 1/2	\$5.20	\$8.00
2	\$7.44	\$10.44
2 1/2	\$11.50	\$20.00
3	\$14.31	\$30.20
4	\$19.98	\$71.50

EG2CS - SHORT WELDING FERRULE

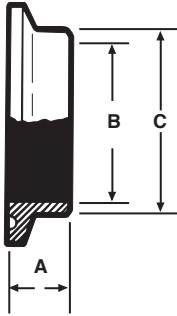

Size Tube OD	T304	T316L
1/4	N/A	\$40.33
3/8	N/A	\$40.33
1/2	N/A	\$8.89
5/8	N/A	\$40.33
3/4	N/A	\$8.89
1	\$4.00	POA
1 1/4	N/A	\$44.44
1 1/2	\$4.00	\$5.00
2	\$4.89	\$6.22
2 1/2	\$7.34	\$11.11
3	\$10.00	\$13.34
4	\$15.73	\$20.89
5	N/A	\$138.00
6	\$67.14	\$78.38
8	\$86.72	\$237.78
10	\$311.11	\$333.33
12	N/A	\$551.11

EG2CS31 - SHORT REDUCING CLAMP FERRULES

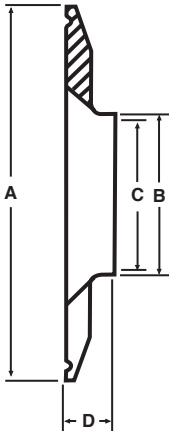

Size Tube OD	T304	T316L
1 X 1/2	N/A	\$37.78
1 X 3/4	N/A	\$37.78
1 1/2 X 1	N/A	\$32.00
2 X 1	N/A	\$40.00
2 X 1 1/2	N/A	\$40.00
2 1/2 X 1 1/2	N/A	\$66.67
2 1/2 X 2	N/A	\$66.67
3 X 1	N/A	\$77.78
3 X 1 1/2	N/A	\$77.78
3 X 2	N/A	\$77.78
3 X 2 1/2	N/A	\$77.78
4 X 1 1/2	N/A	\$115.00
4 X 2	N/A	\$115.00
4 X 2 1/2	N/A	\$115.00
4 X 3	N/A	\$115.00
6 X 4	N/A	\$266.67

EG14W - TANK WELDING FERRULE

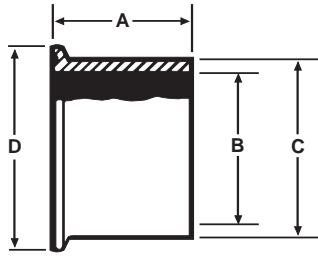

Size Tube OD	T304	T316L
1	\$14.00	\$21.60
1 1/2	\$13.00	\$21.60
2	\$16.00	\$27.30
2 1/2	\$27.80	\$38.11
3	\$31.30	\$50.20
4	\$67.90	\$91.62
6	POA	POA

EG14W-C6L - ASME CODED TANK FERRULE

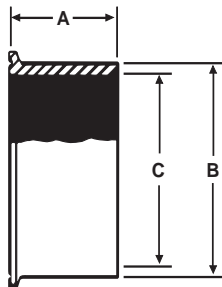

Size Tube OD	T304	T316L
1/2	N/A	\$42.44
1 1/2	N/A	\$42.00
2	N/A	\$60.89
2 1/2	N/A	\$70.44
3	N/A	\$150.62
4	N/A	\$155.56
6	N/A	\$534.60

EG14WSL-C6L - ASME CODED TANK FERRULE LONG

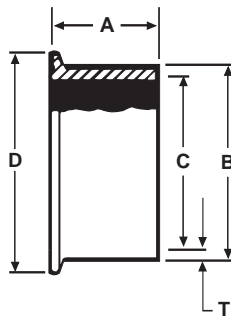

Size Tube OD	T304	T316L
1	N/A	\$123.56
1 1/2	N/A	\$65.56
2	N/A	\$87.11
2 1/2	N/A	\$101.44
3	N/A	\$156.89
4	N/A	\$355.56
6	N/A	\$588.89

EG14WL - TANK WELDING FERRULE

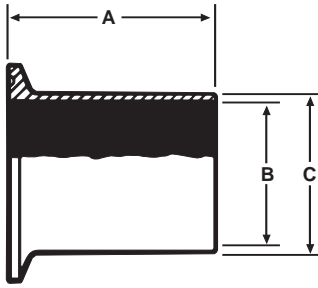

Size Tube OD	T304	T316L
1	\$28.89	\$47.89
1 1/2	\$26.44	\$37.78
2	\$31.89	\$40.00
2 1/2	\$46.00	\$57.80
3	\$61.00	\$76.40
4	\$93.22	\$116.00
6	\$222.22	\$277.78
8	\$466.67	\$511.11
10	\$817.78	\$888.89
12	N/A	\$1,444.44

EG14RT - RUBBER HOSE ADAPTER



Size Tube OD	T304	T316L
1/2	N/A	\$62.33
3/4	N/A	\$64.00
1	\$32.67	\$75.11
1 1/4	N/A	\$100.00
1 1/2	\$32.67	\$63.11
2	\$42.00	\$82.89
2 1/2	\$52.67	\$105.56
3	\$68.22	\$128.89
4	\$173.33	\$206.67
6	\$578.64	\$666.67

EG14RT - RUBBER HOSE ADAPTER REDUCER

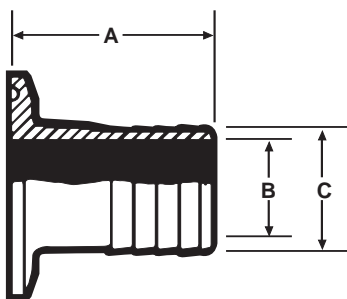

Size Tube OD	T304	T316L
1 X 1/2	N/A	\$73.56
1 X 3/4	N/A	\$97.78
1 1/2 X 1 1/4	N/A	\$126.89
2 X 1	N/A	\$133.11
2 X 1 1/2	N/A	\$133.11
2 1/2 X 2	N/A	\$156.67
3 X 2	N/A	\$166.67
3 X 2 1/2	N/A	\$201.11
4 X 2 1/2	N/A	\$257.78
4 X 3	N/A	\$286.67

EG14HT - TYGON HOSE ADAPTER

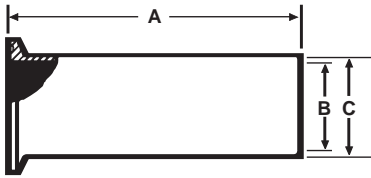

Size Tube OD	T304	T316L
1	\$28.89	\$40.40
1 1/2	\$26.67	\$34.60
2	\$32.78	\$49.11
2 1/2	\$44.11	\$58.67
3	\$51.56	\$72.23
4	\$83.33	\$115.56

EG17PR - ADAPTER

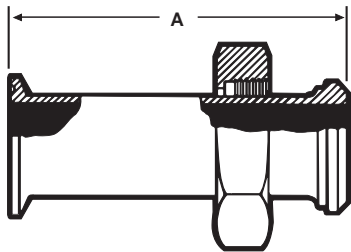

Size Tube OD	T304	T316L
1	\$84.80	\$152.00
1 1/2	\$78.70	\$116.00
2	\$101.00	\$148.00
2 1/2	\$130.00	\$213.00
3	\$179.00	\$293.00
4	\$274.00	\$413.00

EG17TR - ADAPTER



Size Tube OD	T304	T316L
1	\$49.30	\$74.50
1 1/2	\$48.20	\$72.00
2	\$59.90	\$94.70
2 1/2	\$84.00	\$133.00
3	\$99.80	\$159.00
4	\$156.62	\$335.00

EG21 - MALE ADAPTER (N.P.T. Pipe Threads)

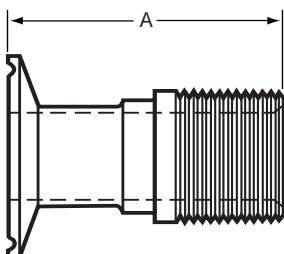

Size Tube OD	T304	T316L
1	\$53.64	\$65.75
1 1/4	T316L	\$197.78
1 1/2	\$55.25	\$68.38
2	\$64.09	\$94.62
2 1/2	\$101.44	\$132.05
3	\$127.47	\$172.78
4	\$173.85	\$258.11
6	\$555.56	\$771.54

EG21-6L - MALE ADAPTER REDUCING

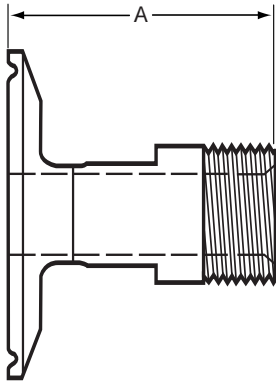

Size Tube OD	T304	T316L
3/4 X 1/2	N/A	See TEG216L
1 X 1/2	N/A	\$97.38
1 X 3/4	N/A	\$101.02
1 1/2 X 1/2	N/A	\$97.38
1 1/2 X 3/4	N/A	\$101.02
1 1/2 X 1 1/4	N/A	\$96.96
2 X 1	N/A	\$100.67
2 X 1 1/4	N/A	\$159.11
2 X 1 1/2	N/A	\$90.00
2 1/2 X 1 1/2	N/A	\$133.33
2 1/2 X 2	N/A	\$181.00
3 X 1 1/2	N/A	\$166.67
3 X 2	N/A	\$193.34
3 X 2 1/2	N/A	\$197.78
4 X 2	N/A	\$306.67
4 X 2 1/2	N/A	\$255.56
4 X 3	N/A	\$244.44
6 X 4	N/A	\$511.11

EG22 - FEMALE ADAPTER (N.P.T. Pipe Threads)

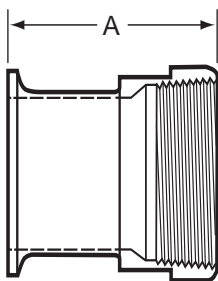

Size Tube OD	T304	T316L
1	\$53.53	\$65.75
1 1/4	POA	POA
1 1/2	\$55.58	\$68.38
2	\$64.80	\$94.62
2 1/2	\$100.62	\$132.05
3	\$127.93	\$172.78
4	\$173.42	\$258.11

EG22 - FEMALE ADAPTER REDUCING

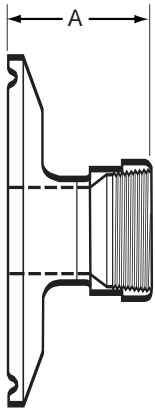

Size Tube OD	T304	T316L
3/4 X 1/2	N/A	See TEG22
1 X 1/2	N/A	\$109.54
1 X 3/4	N/A	\$113.20
1 1/2 X 1/2	N/A	\$109.54
1 1/2 X 3/4	N/A	\$113.20
1 1/2 X 1 1/4	N/A	\$161.89
2 X 1	N/A	\$162.29
2 X 1 1/4	N/A	\$197.78
2 X 1 1/2	N/A	\$149.00
2 1/2 X 1 1/2	N/A	\$174.44
2 1/2 X 2	N/A	\$187.78
3 X 1 1/2	N/A	\$227.78
3 X 2	N/A	\$227.78
3 X 2 1/2	N/A	\$238.89
4 X 2	N/A	\$402.22
4 X 2 1/2	N/A	\$413.33
4 X 3	N/A	\$422.22

EG16A - SOLID END CAP



Size Tube OD	T304	T316L
1/2 & 3/4	N/A	\$6.22
1 & 1 1/2	\$4.00	\$5.00
2	\$5.11	\$6.90
2 1/2	\$8.00	\$11.12
3	\$10.72	\$14.70
4	\$20.56	\$27.04
5	N/A	\$138.89
6	\$80.11	\$98.60
8	N/A	\$222.22
10	N/A	\$611.11
12	N/A	\$824.44

CLAMP FITTINGS

EG23B-6L - CLAMP THERMOMETER CAPS

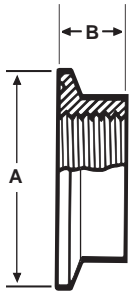

Size Tube OD	T304	T316L
1	N/A	\$58.67
1 1/2	N/A	\$58.67
2	N/A	\$77.78
2 1/2	N/A	\$85.22
3	N/A	\$108.11
4	N/A	\$168.89

GASKETS



Size Tube OD	EG40 (Buna)	EG40F (Buna)	EG40E (EPDM)	EG40FE (EPDM)	EG40V (Viton)	EG40FV (Viton)
1/2	\$1.78	N/A	\$2.11	N/A	\$4.89	N/A
3/4	\$2.11	N/A	\$2.11	N/A	\$5.56	N/A
1	\$0.67	\$1.33	\$1.67	\$2.22	\$5.78	\$8.33
1 1/2	\$0.44	\$1.44	\$1.67	\$2.44	\$4.11	\$6.00
2	\$0.44	\$1.33	\$1.78	\$2.56	\$4.78	\$7.11
2 1/2	\$0.67	\$1.56	\$2.00	\$3.56	\$7.11	\$11.89
3	\$0.89	\$2.22	\$2.22	\$4.00	\$10.22	\$12.44
4	\$1.44	\$2.89	\$2.44	\$4.11	\$12.78	\$13.30
5	\$5.56	POA	\$16.11	POA	\$40.22	POA
6	\$7.78	\$19.89	\$19.78	\$24.22	\$36.67	\$42.22
8	N/A	\$21.89	N/A	\$42.67	N/A	\$71.78
10	N/A	\$32.78	N/A	\$48.89	N/A	\$77.78
12	N/A	\$34.44	N/A	\$53.33	N/A	\$81.67

GASKETS



Size Tube OD	EG40S (Silicone)	EG40FS (Silicone)	EG40T (Teflon)	EG40TS (Tef-Steel)	EG40GR (EPDM)	EG40GRV (Viton)
1/2	\$2.44	\$2.33	\$3.22	\$6.00	\$11.44	\$11.44
3/4	\$2.44	\$2.67	\$3.33	\$6.11	\$11.56	\$11.56
1	\$2.56	\$3.11	\$1.89	\$15.89	\$4.33	\$4.33
1 1/2	\$2.22	\$3.11	\$1.56	\$11.56	\$3.89	\$3.89
2	\$2.44	\$3.33	\$1.67	\$16.44	\$5.11	\$5.11
2 1/2	\$3.33	\$4.22	\$1.89	\$17.78	\$6.00	\$6.00
3	\$3.56	\$5.00	\$2.22	\$23.22	\$6.67	\$6.67
4	\$4.11	\$5.89	\$3.11	\$29.44	\$12.33	\$12.33
5	\$20.56	POA	\$35.22	POA	POA	POA
6	\$18.67	\$20.00	\$28.89	\$74.44	\$34.22	\$34.22
8	N/A	\$32.89	\$60.00	\$100.00	\$93.33	\$93.33
10	N/A	\$34.22	\$77.00	POA	\$135.00	\$135.00
12	N/A	\$41.11	\$180.00	POA	POA	POA

CLAMP FITTINGS

13MHM - HEAVY DUTY CLAMP

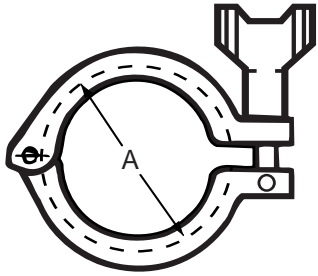

Size Tube OD	T304	T316L
1/2 & 3/4	\$6.11	N/A
1 & 1 1/2	\$7.78	N/A
2	\$9.56	N/A
2 1/2	\$10.89	N/A
3	\$12.23	N/A
4	\$14.67	N/A
5	\$44.44	N/A
6	\$36.51	N/A
8	\$53.58	N/A
10	\$143.00	N/A
12	\$333.33	N/A

13MHMD - DOUBLE HINGED HEAVY DUTY CLAMP

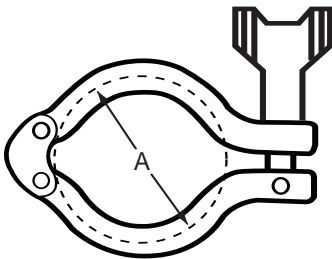

Size Tube OD	T304	T316L
1 & 1 1/2	\$10.78	N/A
2	\$12.18	N/A
2 1/2	\$15.20	N/A
3	\$16.23	N/A
4	\$19.29	N/A

13MHM-H - HEAVY DUTY CLAMP (Wing nut With Hole)

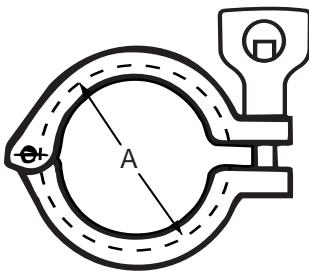

Size Tube OD	T304	T316L
1/2 & 3/4	\$6.11	N/A
1 & 1 1/2	\$7.78	N/A
2	\$9.56	N/A
2 1/2	\$10.89	N/A
3	\$12.23	N/A
4	\$14.67	N/A
5	\$44.44	N/A
6	\$36.51	N/A

13MHHS - THREE PIECE HEAVY DUTY CLAMP

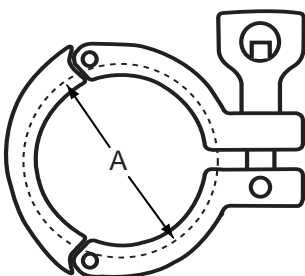

Size Tube OD	T304	T316L
1 1/2	\$14.71	N/A
2	\$16.50	N/A
2 1/2	\$19.80	N/A
3	\$23.12	N/A
4	\$28.13	N/A

13MHP - HIGH PRESSURE CLAMP

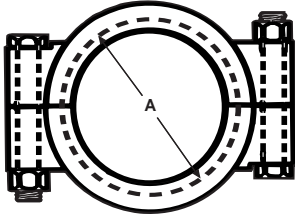

Size Tube OD	T304	T316L
1/2 & 3/4	\$16.20	N/A
1 & 1 1/2	\$15.89	N/A
2	\$20.67	N/A
2 1/2	\$22.67	N/A
3	\$28.67	N/A
4	\$31.12	N/A
6	\$54.44	N/A

EG13 - HINGED CLAMP - (Light Duty)

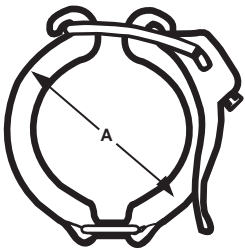

Size Tube OD	T304	T316L
1 & 1 1/2	\$21.53	N/A
2	\$22.67	N/A
2 1/2	\$25.02	N/A
3	\$33.13	N/A
4	\$35.33	N/A

EG28A - 45° CLAMP LATERAL

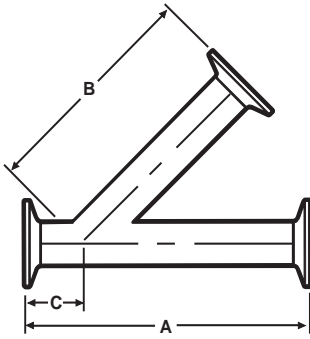

Size Tube OD	T304	T316L
1	\$322.22	\$376.58
1 1/2	\$322.22	\$366.49
2	\$337.78	\$378.42
2 1/2	\$395.56	\$518.02
3	\$431.11	\$587.82
4	\$711.11	\$1028.71
6	\$1,684.44	\$2,034.45

EG28B - CLAMP TRUE Y

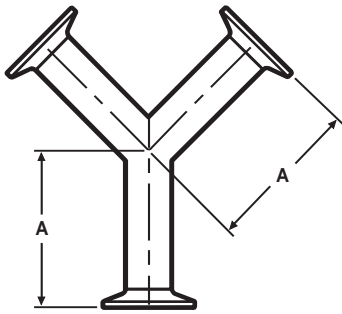

Size Tube OD	304	316L
1	\$322.22	\$376.58
1 1/2	\$322.22	\$366.49
2	\$337.78	\$378.42
2 1/2	\$395.56	\$518.02
3	\$431.11	\$587.82
4	\$711.11	\$1028.71
6	\$1,684.44	\$2,034.44

EG28RA - 45° CLAMP REDUCING LATERAL

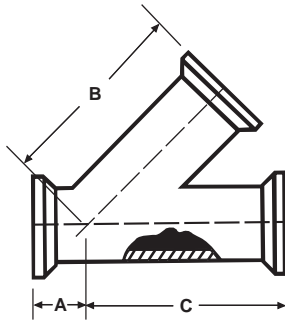

Size Tube OD	T304	T316L
1 1/2 X 1	POA	POA
2 X 1	POA	POA
2 X 1 1/2	POA	POA
2 1/2 X 2	POA	POA
3 X 1	POA	POA
3 X 1 1/2	POA	POA
3 X 2	POA	POA
3 X 2 1/2	POA	POA
4 X 1	POA	POA
4 X 1 1/2	POA	POA
4 X 2	POA	POA
4 X 2 1/2	POA	POA
4 X 3	POA	POA

EG31CC - CONCENTRIC REDUCER

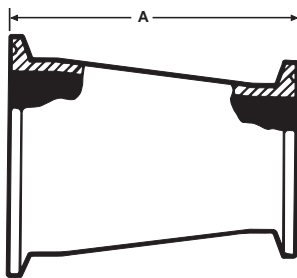

Size Tube OD	T304	T316L
3/4 X 1/2	N/A	\$118.00
1 X 1/2	N/A	\$105.56
1 X 3/4	N/A	\$131.11
1 1/2 X 1/2	N/A	\$151.11
1 1/2 X 3/4	N/A	\$151.11
1 1/2 X 1	\$46.67	\$51.12
1 1/2 X 1 1/4	POA	POA
2 X 1	\$63.69	\$86.67
2 X 1 1/4	POA	POA
2 X 1 1/2	\$49.80	\$54.36
2 1/2 X 1	\$198.00	\$253.33
2 1/2 X 1 1/2	\$67.96	\$73.34
2 1/2 X 2	\$60.60	\$67.34
3 X 1 1/2	\$115.91	\$140.00
3 X 2	\$80.78	\$92.67
3 X 2 1/2	\$74.29	\$80.58
4 X 2	\$153.71	\$180.75
4 X 2 1/2	\$176.33	\$180.15
4 X 3	\$98.87	\$104.44
6 X 3	\$431.11	\$566.67
6 X 4	\$444.44	\$631.12

EG32CC - ECCENTRIC REDUCER

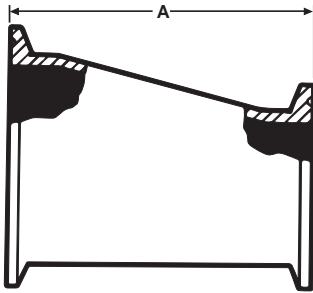

Size Tube OD	T304	T316L
3/4 X 1/2	N/A	\$147.11
1 X 1/2	N/A	\$172.00
1 X 3/4	N/A	\$147.11
1 1/2 X 1/2	N/A	\$276.47
1 1/2 X 3/4	N/A	\$276.47
1 1/2 X 1	\$52.20	\$63.60
1 1/2 X 1 1/4	POA	POA
2 X 1	\$123.11	\$206.22
2 X 1 1/4	POA	POA
2 X 1 1/2	\$59.40	\$71.40
2 1/2 X 1	\$179.11	\$327.78
2 1/2 X 1 1/2	\$81.96	\$99.34
2 1/2 X 2	\$69.00	\$84.22
3 X 1 1/2	\$133.18	\$162.85
3 X 2	\$91.78	\$104.71
3 X 2 1/2	\$119.00	\$123.58
4 X 2	\$202.22	\$200.60
4 X 2 1/2	\$193.78	\$253.67
4 X 3	\$136.64	\$173.11
6 X 3	\$644.44	\$652.00
6 X 4	\$673.33	\$711.12

EG31PC - ADAPTER REDUCER (Concentric)

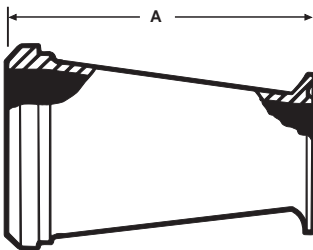

Size Tube OD	T304	T316L
1 1/2 X 1	\$157.78	\$165.56
2 X 1	\$157.78	\$237.78
2 X 1 1/2	\$175.22	\$237.78
2 1/2 X 1 1/2	\$180.56	\$260.00
2 1/2 X 2	\$180.56	\$260.00
3 X 2	\$197.78	\$288.89
3 X 2 1/2	\$197.78	\$288.89
4 X 2 1/2	\$293.33	\$444.44
4 X 3	\$293.33	\$416.67

EG32PC - ADAPTER REDUCER (Eccentric)

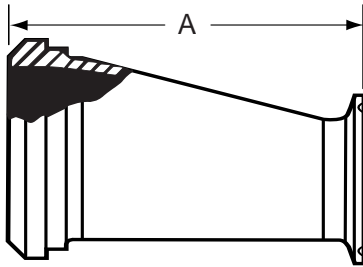

Size Tube OD	T304	T316L
1 1/2 X 1	\$157.78	\$165.56
2 X 1	\$157.78	\$237.78
2 X 1 1/2	\$175.22	\$237.78
2 1/2 X 1 1/2	\$180.56	\$260.00
2 1/2 X 2	\$180.56	\$260.00
3 X 2	\$197.78	\$288.89
3 X 2 1/2	\$197.78	\$288.89
4 X 2 1/2	\$293.33	\$444.44
4 X 3	\$293.33	\$416.67

EG31CP - ADAPTER REDUCER (Concentric)

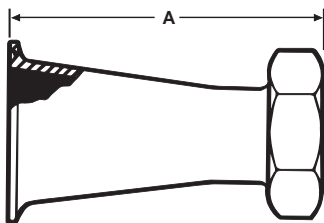

Size Tube OD	T304	T316L
1 1/2 X 1	\$157.78	\$165.56
2 X 1	\$157.78	\$237.78
2 X 1 1/2	\$175.22	\$237.78
2 1/2 X 1 1/2	\$180.56	\$260.00
2 1/2 X 2	\$180.56	\$260.00
3 X 2	\$197.78	\$288.89
3 X 2 1/2	\$197.78	\$288.89
4 X 2 1/2	\$293.33	\$444.44
4 X 3	\$293.33	\$416.67

EG32CP - ADAPTER REDUCER (Eccentric)

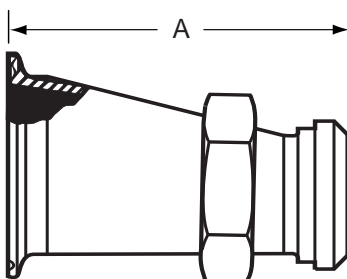

Size Tube OD	T304	T316L
1 1/2 X 1	\$157.78	\$165.56
2 X 1	\$157.78	\$237.78
2 X 1 1/2	\$175.22	\$237.78
2 1/2 X 1 1/2	\$180.56	\$260.00
2 1/2 X 2	\$180.56	\$260.00
3 X 2	\$197.78	\$288.89
3 X 2 1/2	\$197.78	\$288.89
4 X 2 1/2	\$293.33	\$444.44
4 X 3	\$293.33	\$416.67

EG31TC - ADAPTER REDUCER (Concentric)

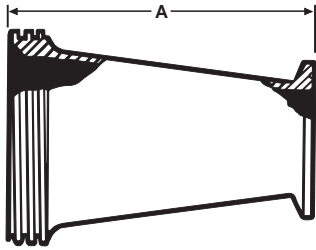

Size Tube OD	T304	T316L
1 1/2 X 1	\$112.22	\$182.22
2 X 1	\$120.00	\$243.33
2 X 1 1/2	\$120.00	\$200.00
2 1/2 X 1 1/2	\$154.44	\$244.44
2 1/2 X 2	\$174.44	\$244.44
3 X 2	\$191.89	\$277.78
3 X 2 1/2	\$191.89	\$283.33
4 X 2 1/2	\$294.44	\$444.44
4 X 3	\$298.89	\$427.78

EG32TC - ADAPTER REDUCER (Eccentric)

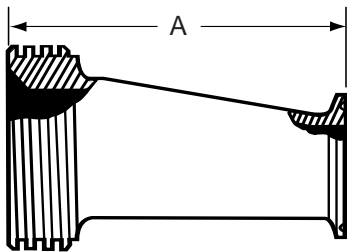

Size Tube OD	T304	T316L
1 1/2 X 1	\$112.22	\$182.22
2 X 1	\$120.00	\$243.33
2 X 1 1/2	\$120.00	\$200.00
2 1/2 X 1 1/2	\$154.44	\$244.44
2 1/2 X 2	\$174.44	\$244.44
3 X 2	\$191.89	\$277.78
3 X 2 1/2	\$191.89	\$283.33
4 X 2 1/2	\$294.44	\$444.44
4 X 3	\$298.89	\$427.78

EG31CT - ADAPTER REDUCER (Concentric)

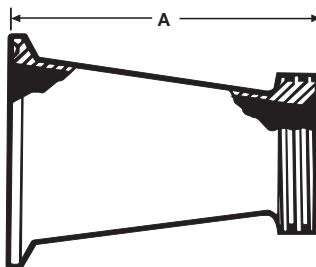

Size Tube OD	T304	T316L
1 1/2 X 1	\$112.22	\$182.22
2 X 1	\$120.00	\$243.33
2 X 1 1/2	\$120.00	\$200.00
2 1/2 X 1 1/2	\$154.44	\$244.44
2 1/2 X 2	\$174.44	\$244.44
3 X 2	\$191.89	\$277.78
3 X 2 1/2	\$191.89	\$283.33
4 X 2 1/2	\$294.44	\$444.44
4 X 3	\$298.89	\$427.78

EG32CT - ADAPTER REDUCER (Eccentric)

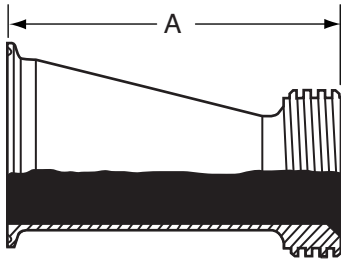

Size Tube OD	T304	T316L
1 1/2 X 1	\$112.22	\$182.22
2 X 1	\$120.00	\$243.33
2 X 1 1/2	\$120.00	\$200.00
2 1/2 X 1 1/2	\$154.44	\$244.44
2 1/2 X 2	\$174.44	\$244.44
3 X 2	\$191.89	\$277.78
3 X 2 1/2	\$191.89	\$283.33
4 X 2 1/2	\$294.44	\$444.44
4 X 3	\$298.89	\$427.78

CLAMP FITTINGS SCHEDULE 5 & 10

EG2CS-5-6L - FERRULE

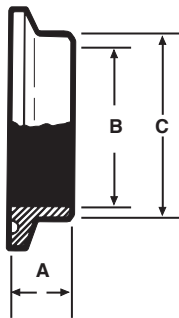

Size Tube OD	T304	T316L
1	N/A	\$30.45
1 1/2	N/A	\$30.45
2	N/A	\$37.78
2 1/2	N/A	\$63.33
3	N/A	\$95.56
4	N/A	\$144.44

EG2CS-10-6L - FERRULE

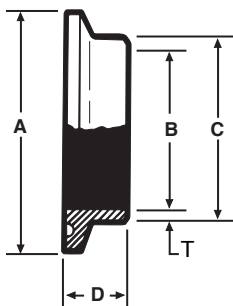

Size Tube OD	T304	T316L
1/2	N/A	POA
3/4	N/A	POA
1	N/A	\$34.89
1 1/2	N/A	\$40.00
2	N/A	\$64.29
2 1/2	N/A	\$91.11
3	N/A	\$101.33
4	N/A	\$124.31

CLAMP FITTINGS SCHEDULE 5 & 10

STAINLESS STEEL FITTINGS
PRICE BOOK

EG14AM7-5-6L - FERRULE

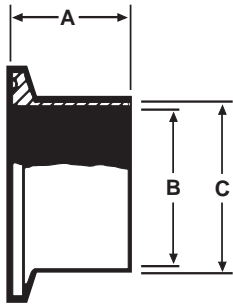

Size Tube OD	T304	T316L
1	N/A	\$43.07
1 1/2	N/A	\$53.33
2	N/A	\$65.64
2 1/2	N/A	\$84.18
3	N/A	\$118.29
4	N/A	\$217.44

EG14AM7-10-6L - FERRULE

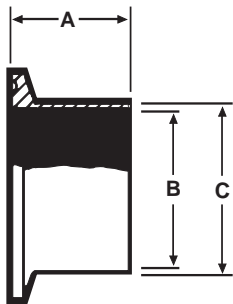

Size Tube OD	T304	T316L
1	N/A	\$39.56
1 1/2	N/A	\$51.11
2	N/A	\$86.22
2 1/2	N/A	\$120.00
3	N/A	\$140.44
4	N/A	\$203.56

EG16A-5-6L - CAP



Size Tube OD	T304	T316L
1	N/A	\$5.00
1 1/2	N/A	\$6.90
2	N/A	\$10.51
2 1/2	N/A	\$14.70
3	N/A	\$93.33
4	N/A	\$133.33

13MHM-5 - CLAMP

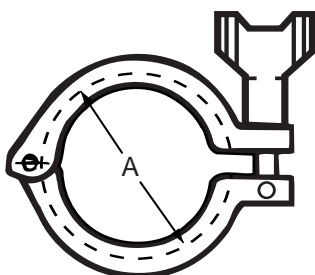

Size Tube OD	T304	T316L
1	\$7.56	N/A
1 1/2	\$8.93	N/A
2	\$10.44	N/A
2 1/2	\$11.76	N/A
3	\$25.64	N/A
4	\$41.33	N/A

CLAMP FITTINGS SCHEDULE 5 & 10

STAINLESS STEEL FITTINGS
PRICE BOOK

GASKETS



SIZE TUBE OD	EG40 - 5 (BUNA)	EG40T - 5 (TEFLON)
1	\$3.67	\$15.44
1 1/2	\$3.67	\$14.56
2	\$3.89	\$15.44
2 1/2	\$4.11	\$17.11
3	\$4.44	\$23.11
4	\$5.22	\$32.56

FITTINGS



Weld Fittings



WELD FITTINGS....

Weld Fittings are used on permanent installations where process piping and equipment can be cleaned in place (CIP) and removal from the system is not required. Weld Fittings are offered in nominal tube sizes 1/2" through 8" in T304 and T316L materials. Uniform wall thickness for 1/2" through 3" sizes measure .065 (16 ga). In 4" size, wall thickness measures .083 (14 ga), 6" and 8" .109 (12 ga).

VNE offers Polished ID and OD Fittings for immediate shipment. Other polished combinations may be ordered. Our Weld Fittings meet all 3A requirements.

WELD FITTING SPECIFICATIONS....

Size Range: 1/2" OD through 8" OD

Materials: T304
T316L

Finish: No. 7 - ID & OD
No. 5 - OD only
No. 3 - ID only
No. 1 - unpolished

ORDERING SPECIFICATIONS....

Specify:

- Quantity
- Product description or Part No.
- Size
- Material Type
- Polish Requirements

LIMITED WARRANTY....

VNE Corporation products are warranted to be free from defects in material and workmanship for a period of one year from the date of shipment. Any product that proves to be defective shall be repaired or replaced at the option of VNE, providing it has been used as recommended and in strict accordance with recognized piping practices, and that has not been subject to extraordinary service, such as encountered under severe corrosive or abrasive conditions.

VNE makes no warranties, express or implied, other than those listed above.

VNE shall not be liable for any consequential, indirect, incidental or contingent damages.

VNE CORPORATION

P.O. Box 1698 • 1149 Barberry Drive • Janesville, WI 53547

TEL: 608-756-4930 • FAX: 608-756-3643 • 1-800-356-1111 • Web site: vnestainless.com

WELD FITTINGS

VNE	TRI-CLOVER	WAUKESHA	G & H	JENSEN
E2S	L2S	2CW	G2S	J2S
E2C	L2CM	2CKW	G2C	J2CM
E2T	L2C	2TW	G2T	J2C
E2F	L2F	2FW	G2F	J2F
E2KS	L2KS	2KW	G2KS	J2KS
E2KC	L2KM	2KKW	G2KC	J2KM
E2KT	L2K	2KT	G2KT	J2K
E2KP	L2P	2KP	G2KP	J2P
E2WU	L2WU	2WU	G2WU	J2WU
E7WWW	L7WWW	7W	G7WWW	J7WWW
E7WWC	L7WWM	7WWK	G7WWC	J7WWM
E7WWT	L7WWT	7WWT	G7WWT	J7WWT
E7WCW	L7WMW	7WKW	G7WCW	J7WMW
E7WTW	L7WTW	7WTW	G7WTW	J7WTW
E7WCC	L7WMM	7WKK	G7WCC	J7WMM
E7WTT	L7WTT	7WTT	G7WTT	J7WTT
E7CCW	L7MMW	7KKW	G7CCW	J7MMW
E7TTW	L7TTW	7TTW	G7TTW	J7TTW
E7RWWW	L7RWWW	7WR	G7RWWW	J7RWWW
E9WWWWW	L9WWWWW	9W	G9WWWWW	J9WWWWW
E31WW	L31	31W	G31	J31
E32WW	L32	32W	G32	J32
E10WW	DL10WW	10CW	10WW	J10WW
E10RWW	DL10WWR	10CWR	10WWR	J10WWR
E11WW	DL11WWW	11CW	11WWW	J11WWW
E11RWW	DL11WWWR	11CWR	11WWWR	J11WWWR
E28WA	L28WA	28WA	G28WA	J28WA
E28WB	L28WB	28WB	G28WB	J28WB

2WCL - 90° ELBOW SHORT TANGENT

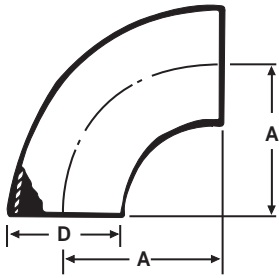

Size Tube OD	T304	T316L
1	\$16.89	\$21.56
1 1/4	\$57.78	\$81.67
1 1/2	\$14.44	\$19.56
2	\$18.44	\$24.11
2 1/2	\$30.00	\$39.78
3	\$34.44	\$51.12
4	\$74.22	\$93.34
6	\$466.67	\$555.56
8	\$822.22	\$944.45

E2S - 90° ELBOW

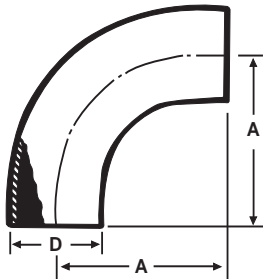

Size Tube OD	T304	T316L
1	\$19.04	\$24.44
1 1/2	\$20.00	\$24.44
2	\$22.00	\$32.58
2 1/2	\$31.74	\$48.89
3	\$43.89	\$73.34
4	\$81.52	\$126.45

E2C - 90° ELBOW

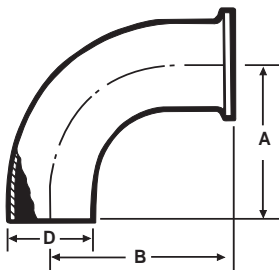

Size Tube OD	T304	T316L
1	\$33.92	\$46.10
1 1/2	\$33.92	\$46.20
2	\$41.16	\$58.60
2 1/2	\$55.27	\$85.49
3	\$70.78	\$116.00
4	\$142.89	\$235.56
6	\$877.78	\$722.22

E2F - 90° ELBOW

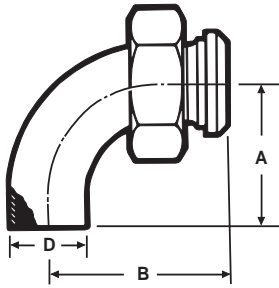

Size Tube OD	T304	T316L
1	\$77.33	\$112.31
1 1/2	\$76.00	\$116.47
2	\$88.22	\$142.11
2 1/2	\$133.33	\$193.53
3	\$150.83	\$263.45
4	\$224.10	\$386.93

E2T - 90° ELBOW

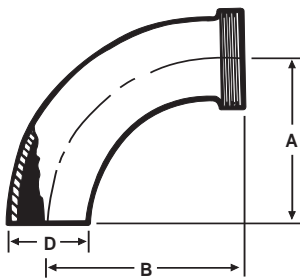

Size Tube OD	T304	T316L
1	\$71.11	\$79.00
1 1/2	\$67.56	\$75.00
2	\$75.67	\$84.11
2 1/2	\$110.00	\$125.56
3	\$128.44	\$180.44
4	\$198.44	\$285.98

E2WU - 180° U BEND

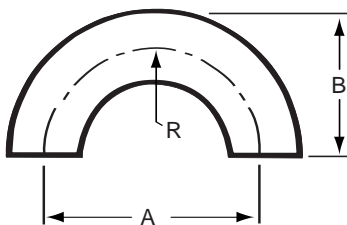

Size Tube OD	T304	T316L
1/2	N/A	POA
3/4	N/A	POA
1	\$166.67	\$185.56
1 1/4	POA	POA
1 1/2	\$211.11	\$234.44
2	\$217.78	\$244.44
2 1/2	\$288.89	\$322.22
3	\$333.33	\$388.89
4	\$388.89	\$455.56
6	\$1,340.00	\$1,666.67

E2WK - 45° ELBOW SHORT TANGENT

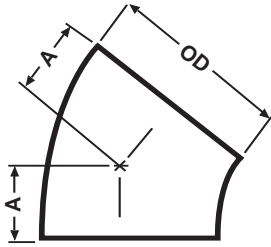

Size Tube OD	T304	T316L
1	\$22.67	\$35.11
1 1/4	N/A	\$88.89
1 1/2	\$22.67	\$33.78
2	\$25.78	\$39.33
2 1/2	\$37.56	\$46.67
3	\$42.11	\$56.67
4	\$73.33	\$117.33
6	\$344.45	\$357.78
8	\$522.52	\$677.78

E2KS - 45° ELBOW

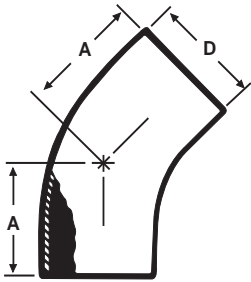

Size Tube OD	T304	T316L
1	\$20.00	\$23.11
1 1/2	\$17.44	\$21.33
2	\$21.47	\$27.05
2 1/2	\$31.18	\$40.74
3	\$42.50	\$57.16
4	\$66.67	\$106.98

E2KC - 45° ELBOW

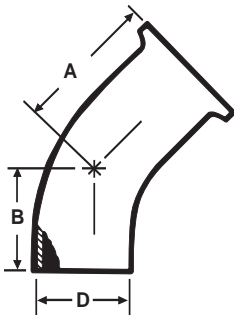

Size Tube OD	T304	T316L
1	\$91.33	\$72.78
1 1/2	\$62.56	\$70.22
2	\$68.00	\$75.56
2 1/2	\$97.00	\$122.22
3	\$114.44	\$146.67
4	\$161.11	\$232.22
6	\$477.78	\$633.33

E2KT - 45° ELBOW

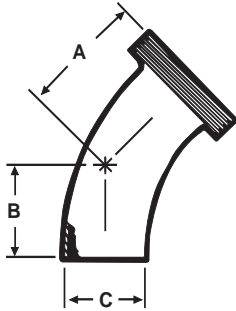

Size Tube OD	T304	T316L
1	\$66.67	\$74.11
1 1/2	\$65.89	\$73.22
2	\$70.44	\$81.67
2 1/2	\$133.33	\$113.20
3	\$117.78	\$164.73
4	\$201.73	\$299.87

E2KP - 45° ELBOW

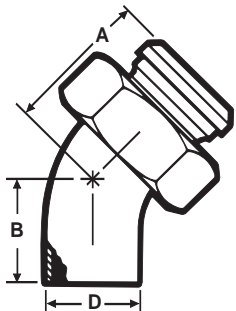

Size Tube OD	T304	T316L
1	\$75.22	\$83.56
1 1/2	\$74.33	\$82.56
2	\$86.11	\$95.67
2 1/2	\$121.11	\$134.44
3	\$188.89	\$181.36
4	\$240.64	\$323.93

E7WWW - TEE

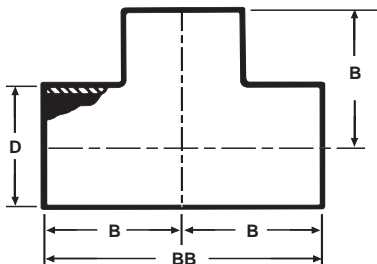

Size Tube OD	T304	T316L
1	\$30.89	\$37.11
1 1/4	POA	POA
1 1/2	\$30.89	\$34.22
2	\$33.00	\$40.44
2 1/2	\$40.67	\$47.94
3	\$56.40	\$70.58
4	\$84.30	\$114.53
6	\$822.22	\$900.00
8	\$1,054.56	\$1,233.33

E7RWWW - REDUCING TEE

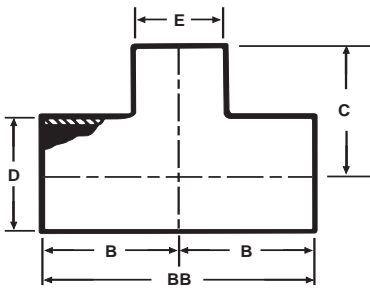

Size Tube OD	T304	T316L
1 1/2 X 1	\$55.56	\$56.89
1 1/2 X 1 1/4	POA	POA
2 X 1	\$83.33	\$132.89
2 X 1 1/2	\$58.67	\$64.56
2 1/2 X 1	\$124.67	\$136.67
2 1/2 X 1 1/2	\$104.44	\$136.67
2 1/2 X 2	\$64.29	\$68.67
3 X 1	\$134.44	\$188.89
3 X 1 1/2	\$127.78	\$196.67
3 X 2	\$92.67	\$138.89
3 X 2 1/2	\$92.67	\$138.89
4 X 1 1/2	\$231.11	\$288.89
4 X 2	\$231.11	\$295.56
4 X 2 1/2	\$231.11	\$295.56
4 X 3	\$148.56	\$146.44
6 X 2	\$555.56	\$777.78
6 X 3	\$555.56	\$777.78
6 X 4	\$555.56	\$777.78

E7WWCS - SHORT CLAMP BRANCH TEE

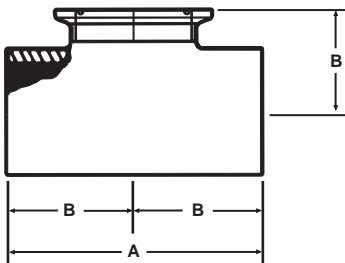

Size Tube OD	T304	T316L
1	POA	POA
1 1/2	POA	POA
2	POA	POA
2 1/2	POA	POA
3	POA	POA
4	POA	POA

E7RWWCS - REDUCING SHORT CLAMP BRANCH TEE

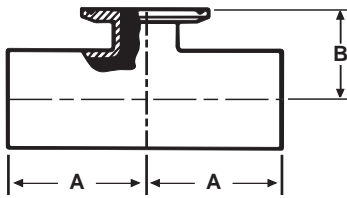

Size Tube OD	T304	T316L
3/4 X 1/2	N/A	POA
1 X 1/2	N/A	POA
1 X 3/4	N/A	POA
1 1/2 X 1/2	N/A	POA
1 1/2 X 3/4	N/A	POA
1 1/2 X 1	N/A	POA
2 X 1/2	N/A	POA
2 X 1 3/4	N/A	POA
2 X 1	N/A	POA
2 X 1 1/2	N/A	POA
2 1/2 X 1/2	N/A	POA
2 1/2 X 3/4	N/A	POA
2 1/2 X 1	N/A	POA
2 1/2 X 1 1/2	N/A	POA
2 1/2 X 2	N/A	POA
3 X 1/2	N/A	POA
3 X 3/4	N/A	POA
3 X 1	N/A	POA
3 X 1 1/2	N/A	POA
3 X 2	N/A	POA
3 X 2 1/2	N/A	POA
4 X 1/2	N/A	POA
4 X 3/4	N/A	POA
4 X 1	N/A	POA
4 X 1 1/2	N/A	POA
4 X 2	N/A	POA
4 X 2 1/2	N/A	POA
4 X 3	N/A	POA
6 X 4	N/A	POA

E7WWC - TEE WELD X WELD X CLAMP

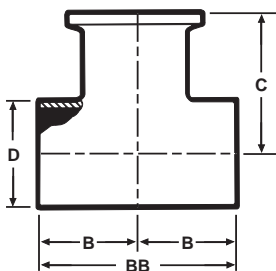

Size Tube OD	T304	T316L
1	\$88.11	\$97.89
1 1/2	\$91.11	\$101.22
2	\$97.89	\$108.78
2 1/2	\$116.67	\$130.00
3	\$133.33	\$148.89
4	\$172.22	\$222.84
6	POA	POA

E7WWT - TEE WELD X WELD X THREAD

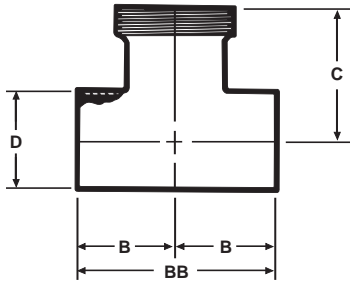

Size Tube OD	T304	T316L
1	\$88.11	\$97.89
1 1/2	\$91.11	\$101.22
2	\$97.89	\$108.78
2 1/2	\$118.09	\$144.89
3	\$157.33	\$185.33
4	\$220.27	\$273.65

E7WCW - TEE WELD X CLAMP X WELD

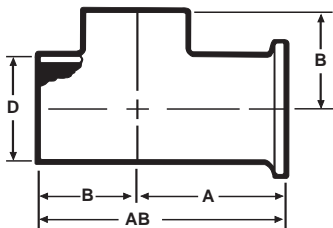

Size Tube OD	T304	T316L
1	\$88.11	\$97.89
1 1/2	\$91.11	\$101.22
2	\$97.89	\$108.78
2 1/2	\$116.67	\$130.00
3	\$183.78	\$160.22
4	\$189.58	\$232.69
6	POA	POA

E7WTW - TEE THREADED ONE END - WELD X THREAD X WELD

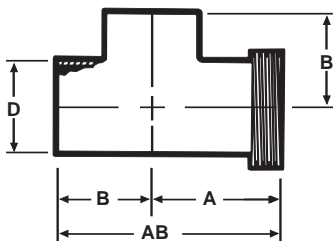

Size Tube OD	T304	T316L
1	\$88.11	\$97.98
1 1/2	\$91.11	\$101.22
2	\$97.89	\$108.78
2 1/2	\$116.67	\$144.89
3	\$157.33	\$185.33
4	\$219.89	\$273.65

E7WCC - TEE WELD X CLAMP X CLAMP

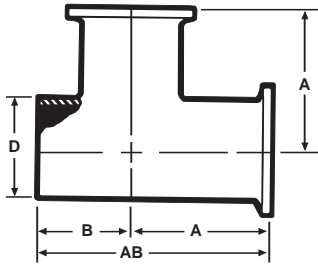

Size Tube OD	T304	T316L
1	\$97.00	\$107.78
1 1/2	\$104.44	\$114.44
2	\$111.11	\$123.33
2 1/2	\$134.44	\$148.89
3	\$159.31	\$186.73
4	\$222.40	\$271.89
6	POA	POA

E7WTT - TEE WELD X THREAD X THREAD

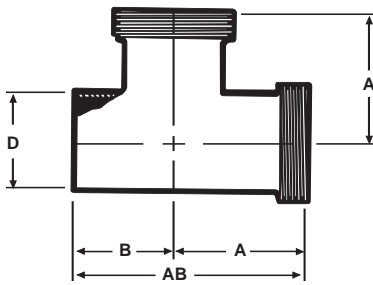

Size Tube OD	T304	T316L
1	\$97.00	\$107.78
1 1/2	\$102.78	\$114.44
2	\$111.11	\$138.42
2 1/2	\$147.42	\$179.71
3	\$214.00	\$230.22
4	\$275.18	\$390.91

E7CCW - TEE CLAMP X CLAMP X WELD

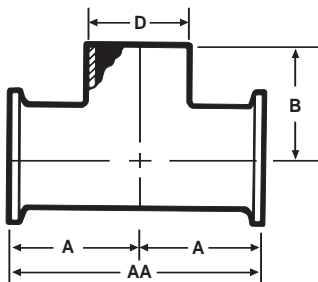

Size Tube OD	T304	T316L
1	\$97.00	\$143.78
1 1/2	\$102.78	\$150.22
2	\$111.11	\$155.11
2 1/2	\$199.56	\$216.44
3	\$159.31	\$253.33
4	\$222.40	\$346.67
6	POA	POA

E7TTW - TEE THREAD X THREAD X WELD

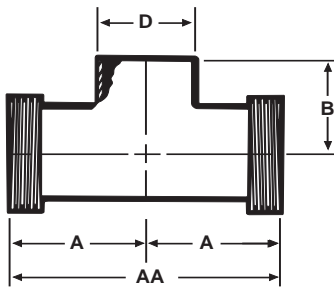

Size Tube OD	T304	T316L
1	\$97.00	\$137.78
1 1/2	\$102.78	\$144.67
2	\$111.11	\$170.00
2 1/2	\$147.42	\$197.56
3	\$193.80	\$230.22
4	\$275.18	\$390.91

E9WWW - CROSS

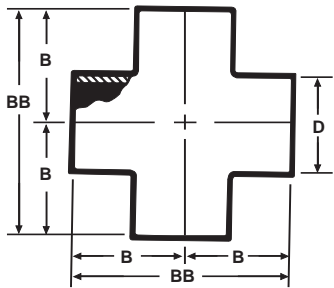

Size Tube OD	T304	T316L
1	\$87.00	\$146.67
1 1/2	\$80.00	\$146.67
2	\$99.78	\$167.13
2 1/2	\$103.56	\$203.91
3	\$144.00	\$271.18
4	\$222.22	\$346.67
6	POA	POA

E14WA - TYPE A STUB END WITH GROOVES

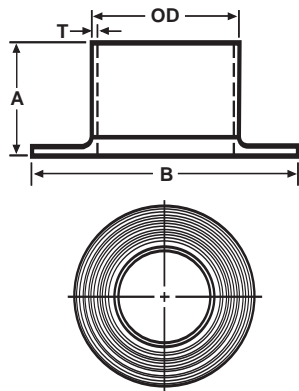

Size Tube OD	T304	T316L
1/2	N/A	\$115.56
3/4	N/A	\$115.56
1	N/A	\$97.33
1 1/4	N/A	POA
1 1/2	N/A	\$97.33
2	N/A	\$124.44
2 1/2	N/A	\$136.67
3	N/A	\$200.00
4	N/A	\$300.00
6	N/A	\$757.78

E16W - WELD CAP

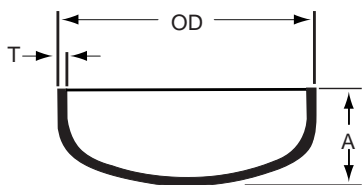

Size Tube OD	T304	T316L
1	\$26.67	\$28.89
1 3/4	POA	POA
1 1/2	\$28.89	\$31.11
2	\$30.00	\$35.22
2 1/2	\$35.56	\$40.00
3	\$53.78	\$51.56
4	\$59.33	\$62.22
6	POA	\$355.56

E28WA - 45° LATERAL

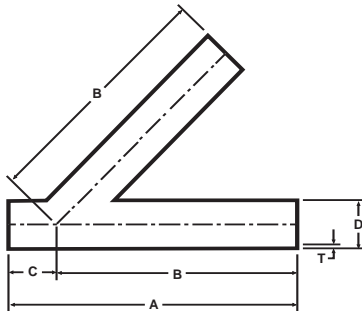

Size Tube OD	T304	T316L
1	\$222.22	\$261.11
1 1/2	\$242.22	\$261.11
2	\$277.78	\$305.56
2 1/2	\$311.11	\$366.67
3	\$344.44	\$413.31
4	\$555.56	\$655.56
6	\$1,500.00	\$2,157.78

E28WB - TRUE Y

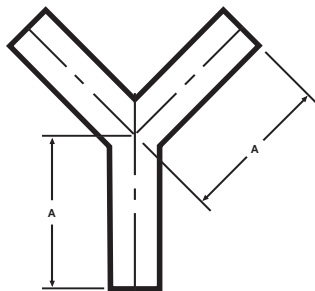

Size Tube OD	T304	T316L
1	\$222.22	\$261.11
1 1/2	\$222.22	\$261.11
2	\$257.78	\$305.56
2 1/2	\$311.11	\$366.67
3	\$344.44	\$405.56
4	\$555.56	\$877.78
6	\$1,500.00	\$2,177.78

E28RWA - 45° REDUCING LATERAL

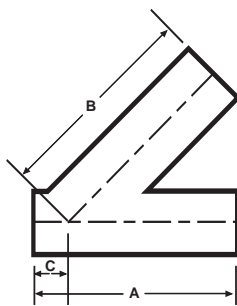

Size Tube OD	T304	T316L
1 1/2 X 1	POA	POA
2 X 1	POA	POA
2 X 1 1/2	POA	POA
2 1/2 X 2	POA	POA
3 X 1	POA	POA
3 X 1 1/2	POA	POA
3 X 2	POA	POA
3 X 2 1/2	POA	POA
4 X 1	POA	POA
4 X 1 1/2	POA	POA
4 X 2	POA	POA
4 X 2 1/2	POA	POA
4 X 3	POA	POA

E31WW - CONCENTRIC REDUCER

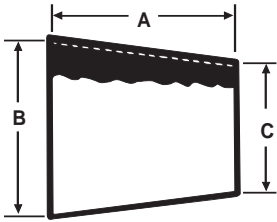

Size Tube OD	T304	T316L
3/4 X 1/2	N/A	\$74.44
1 X 1/2	N/A	\$68.89
1 X 3/4	N/A	\$55.56
1 1/2 X 1/2	N/A	\$100.67
1 1/2 X 3/4	N/A	\$82.22
1 1/2 X 1	\$24.02	\$29.38
1 1/2 X 1 1/4	POA	\$96.89
2 X 1	\$44.36	\$63.78
2 X 1 1/4	N/A	\$133.33
2 X 1 1/2	\$25.11	\$34.16
2 1/2 X 1 1/2	\$42.22	\$72.89
2 1/2 X 2	\$29.30	\$43.24
3 X 1 1/2	\$76.56	\$106.51
3 X 2	\$43.06	\$54.47
3 X 2 1/2	\$51.44	\$87.90
4 X 2	\$116.44	\$153.00
4 X 2 1/2	\$128.89	\$144.00
4 X 3	\$63.90	\$88.02
6 X 2	\$655.56	\$700.00
6 X 3	\$333.33	\$388.89
6 X 4	\$333.33	\$388.89

E31CW - CONCENTRIC REDUCER CLAMP X WELD

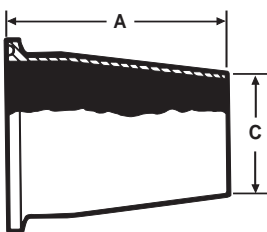

Size Tube OD	T304	T316L
1 1/2 X 1	\$65.22	\$77.78
2 X 1 1/2	\$76.67	\$106.67
2 1/2 X 1 1/2	\$84.44	\$115.56
2 1/2 X 2	\$99.56	\$102.22
3 X 2	\$122.22	\$128.89
3 X 2 1/2	\$134.44	\$140.00
4 X 2	\$229.91	\$235.56
4 X 2 1/2	\$185.75	\$197.78
4 X 3	\$175.56	\$182.22
6 x 4	\$507.67	\$555.56

E31PW - CONCENTRIC REDUCER PLAIN BEVEL X WELD

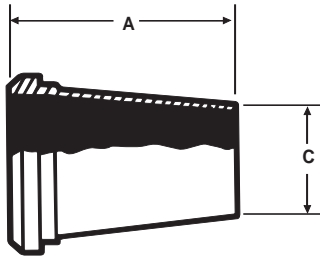

Size Tube OD	T304	T316L
1 1/2 X 1	\$70.44	\$77.78
2 X 1 1/2	\$100.00	\$106.67
2 1/2 X 1 1/2	\$90.11	\$115.56
2 1/2 X 2	\$94.89	\$102.22
3 X 2	\$128.89	\$128.89
3 X 2 1/2	\$141.11	\$140.00
4 X 2	\$221.91	\$235.56
4 X 2 1/2	\$205.44	\$220.00
4 X 3	\$183.33	\$188.89

E32WW - ECCENTRIC REDUCER

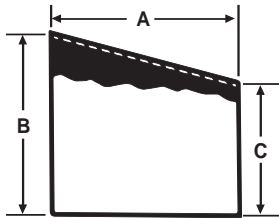

Size Tube OD	T304	T316L
3/4 X 1/2	N/A	\$108.89
1 X 1/2	N/A	\$137.78
1 X 3/4	N/A	\$142.23
1 1/2 X 1/2	N/A	\$188.89
1 1/2 X 3/4	N/A	\$188.89
1 1/2 X 1	\$38.98	\$44.33
1 1/2 X 1 1/4	POA	POA
2 X 1	\$92.27	\$91.11
2 X 1 1/4	POA	POA
2 X 1 1/2	\$40.53	\$50.58
2 1/2 X 1	\$161.12	\$282.23
2 1/2 X 1 1/2	\$66.44	\$97.78
2 1/2 X 2	\$44.80	\$53.47
3 X 2	\$72.50	\$71.94
3 X 2 1/2	\$74.74	\$92.54
4 X 2	\$168.89	\$181.22
4 X 2 1/2	\$139.33	\$173.43
4 X 3	\$86.69	\$115.58
6 X 2	\$688.89	\$777.78
6 X 3	\$366.67	\$422.22
6 X 4	\$366.67	\$422.22

E32CW - ECCENTRIC REDUCER CLAMP X WELD

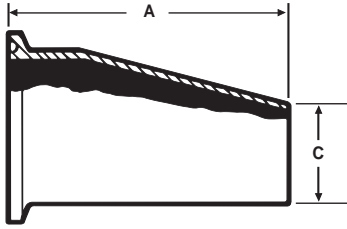

Size Tube OD	T304	T316L
1 1/2 X 1	\$80.56	\$166.89
2 X 1 1/2	\$84.33	\$124.44
2 1/2 X 1 1/2	\$102.00	\$141.11
2 1/2 X 2	\$105.00	\$174.44
3 X 2	\$133.33	\$204.44
3 X 2 1/2	\$158.89	\$216.67
4 X 2	\$295.47	\$321.11
4 X 2 1/2	\$231.18	\$305.56
4 X 3	\$206.67	\$417.78
6 X 4	POA	POA

E17WW-6L - TUBE X PIPE ADAPTER

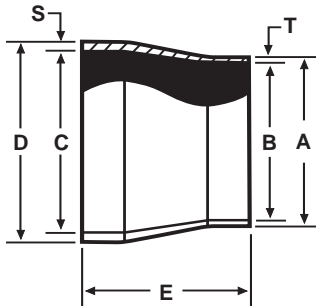

Size Tube OD	SCH 5	SCH 10	SCH 40
1/2	\$48.89	\$54.44	\$58.11
3/4	\$48.89	\$54.44	\$58.11
1	\$64.00	\$69.33	\$62.22
1 1/2	\$64.00	\$69.33	\$68.56
2	\$74.89	\$80.44	\$77.78
2 1/2	\$88.22	\$95.56	\$90.89
3	\$94.00	\$100.00	\$96.11
4	\$188.89	\$188.89	\$188.89
6	\$420.00	\$420.00	\$420.00

FITTINGS



**Bevel Seat Fittings
John Perry Fittings**



BEVEL SEAT FITTINGS....

Bevel Seat Fittings are used on process equipment and piping to ensure rigidity of the system. Bevel Seat Unions consist of a Threaded Bevel Ferrule mated with a Plain Bevel Ferrule. Both are offered in T304 and T316L material. Hex Union Nuts made of only T304 material are used to complete the union. Gaskets for VNE's Bevel Seat Unions are not required for positive shut-off. However, gaskets may be purchased upon request.

VNE's Bevel Seat Fittings meet all 3A requirements and are available in 1" through 4" sizes.

BEVEL SEAT SPECIFICATIONS....

Size Range: 1" OD through 4" OD

Materials: T304
T316L

Finish: No. 7 - ID & OD
No. 5 - OD only
No. 3 - ID only
No. 1 - unpolished

ORDERING SPECIFICATIONS....

Specify:

- Quantity
- Product description or Part No.
- Size
- Material Type
- Polish Requirements

LIMITED WARRANTY....

VNE Corporation products are warranted to be free from defects in material and workmanship for a period of one year from the date of shipment. Any product that proves to be defective shall be repaired or replaced at the option of VNE, providing it has been used as recommended and in strict accordance with recognized piping practices, and that has not been subject to extraordinary service, such as encountered under severe corrosive or abrasive conditions.

VNE makes no warranties, express or implied, other than those listed above.

VNE shall not be liable for any consequential, indirect, incidental or contingent damages.

VNE CORPORATION

P.O. Box 1698 • 1149 Barberry Drive • Janesville, WI 53547

TEL: 608-756-4930 • FAX: 608-756-3643 • 1-800-356-1111 • Web site: vnestainless.com

BEVEL SEAT TYPE

VNE	TRI-CLOVER	WAUKESHA	G & H	JENSEN
2C	2C	2C	2C	2C
2E	2E	2E	2E	2E
2F	2F	2F	2F	2F
2F-31	2F-31	2F-31	2F-31	2F-31
2K	2K	2K	2K	2K
2P	2P	2P	2P	2P
7	7	7	7	7
7A	7A	7A	7A	7A
7B	7B	7B	7B	7B
9	9	9	9	9
9A	9A	9A	9A	9A
10C	D10C	10C	10C	10C
10RC	D10CR	10CR	D10CR	10CR
11C	D11C	11C	11C	11C
11RC	D11CR	11CR	11RC	11CR
13H	13H	13H	13H	13H
14	14	14	14	14
14A	L14A7	14A	G14A	14A
14AHR	14AHR	14AHR	14AHR	14AHR
14AHT	14AHT	14AHT	14AHT	14AHT
14R	14R	14R	14R	14R
14W	14W	14W	14W	14W
14-22	14-22	14-22	14-22	14-18
14WL	14WL	14WL	14WL	14WL
14-19	14-19	21F	21F	14-19
14PR	14PRF	14RW	S2FS	14++
15	15	15	15	15
15TR	15TRF	15RW	S2CS	15++
15A	L15A7	15A	G15A	15A
15AHR	15AHR	15AHR	15AHR	15AHR
15AHT	15AHT	15AHT	15AHT	15AHT
15R	15R	15R	15R	15R
15W	15W	15W	15W	15W
15WL	15WL	15WL	15WL	15WL
16A	16A	16A	16A	16A
21	21	21	21	21
23B	23B	23B	23B	23B
22	22	22	22	22
31TT	31TT	31TT	31TT	31TT
31TP	31TP	31TP	31TP	31TP
31-14F	31-14F	31-14F	31-14F	31-14F
31-15F	31-15F	31-15F	31-15F	31-15F
32-14F	32-14F	32-14F	32-14F	32-14F
32-15F	32-15F	32-15F	32-15F	32-15F
45H	45H	45H	45H	45H

BEVEL SEAT FITTINGS

2C - 90° ELBOW THREADED

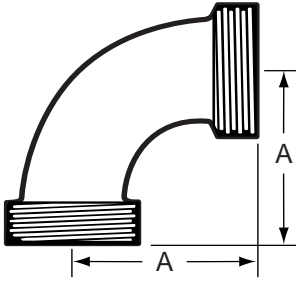

Size Tube OD	T304	T316L
1	\$60.43	\$77.78
1 1/2	\$56.27	\$80.00
2	\$67.60	\$86.30
2 1/2	\$91.60	\$158.47
3	\$123.73	\$223.67
4	\$213.33	\$386.00

2E - 90° ELBOW BEVEL SEAT WITH 13H NUT

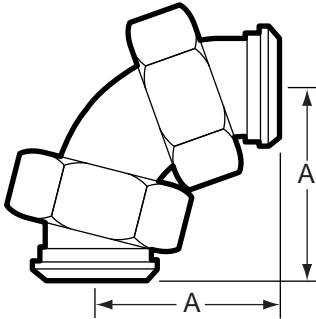

Size Tube OD	T304	T316L
1	\$124.44	\$141.00
1 1/2	\$135.33	\$179.56
2	\$173.00	\$237.78
2 1/2	\$182.00	\$281.00
3	\$255.56	\$334.00
4	\$436.00	\$644.44

2F - 90° ELBOW THREADED X 13H NUT

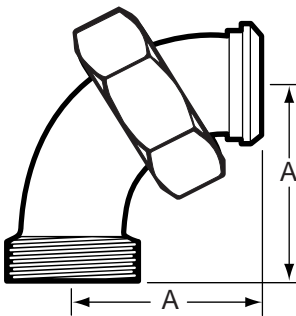

Size Tube OD	T304	T316L
1	\$71.09	\$102.58
1 1/2	\$77.78	\$104.44
2	\$95.44	\$124.00
2 1/2	\$122.22	\$177.76
3	\$152.04	\$243.02
4	\$254.84	\$466.00

2K - 45° ELBOW THREADED

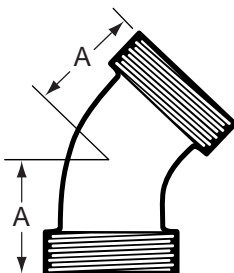

Size Tube OD	T304	T316L
1	\$62.44	\$88.42
1 1/2	\$74.22	\$90.00
2	\$91.78	\$112.95
2 1/2	\$123.56	\$150.71
3	\$153.33	\$215.96
4	\$175.31	\$400.64

2P - 45° ELBOW 13H NUT X THREAD

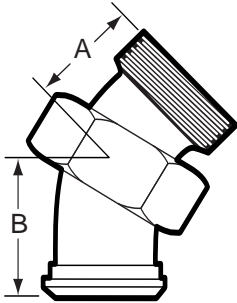

Size Tube OD	T304	T316L
1	\$71.09	\$102.58
1 1/2	\$77.78	\$104.44
2	\$95.44	\$125.29
2 1/2	\$122.22	\$177.76
3	\$152.04	\$243.02
4	\$254.84	\$466.00

7 - TEE ALL ENDS THREADED

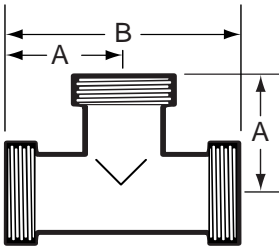

Size Tube OD	T304	T316L
1	\$100.56	\$111.00
1 1/2	\$109.89	\$115.56
2	\$126.33	\$131.11
2 1/2	\$162.00	\$170.22
3	\$169.56	\$208.87
4	\$264.34	\$321.80

7A - TEE THREADED X THREADED X 13H NUT

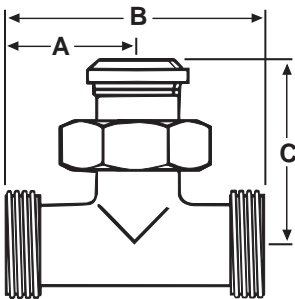

Size Tube OD	T304	T316L
1	\$105.00	\$136.27
1 1/2	\$126.00	\$177.67
2	\$146.89	\$183.07
2 1/2	\$186.44	\$251.44
3	\$215.89	\$329.96
4	\$337.22	\$609.09

7B - TEE THREADED X 13H NUT X THREADED

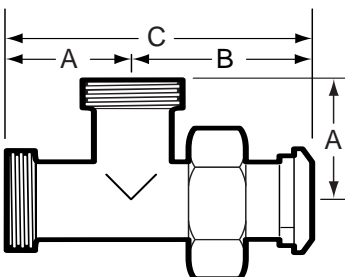

Size Tube OD	T304	T316L
1	\$105.00	\$136.26
1 1/2	\$126.00	\$177.67
2	\$146.89	\$183.07
2 1/2	\$186.44	\$251.44
3	\$215.89	\$329.95
4	\$337.22	\$609.09

9 - CROSS THREADED

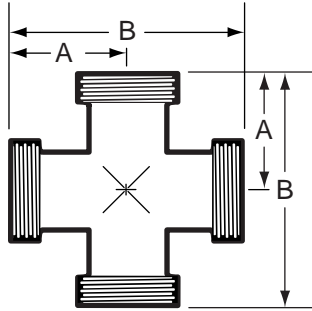

Size Tube OD	T304	T316L
1	\$194.22	\$283.40
1 1/2	\$212.05	\$298.67
2	\$253.44	\$388.80
2 1/2	\$349.47	\$554.36
3	\$403.89	\$751.96
4	\$746.67	\$1,271.13

13H - HEX UNION NUT

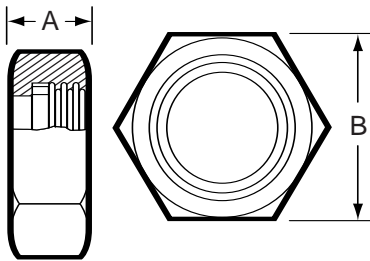

Size Tube OD	T304	T316L
1	\$9.56	N/A
1 1/2	\$14.00	N/A
2	\$17.56	N/A
2 1/2	\$25.56	N/A
3	\$31.12	N/A
4	\$56.38	N/A

14 - PLAIN RECESSED FERRULE

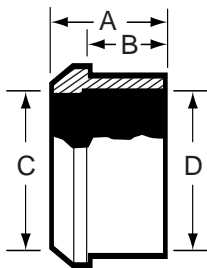

Size Tube OD	T304	T316L
1	N/A	\$49.22
1 1/2	N/A	\$46.87
2	N/A	\$62.78
2 1/2	N/A	\$100.11
3	N/A	\$116.82
4	N/A	\$198.29

14R - PLAIN RECESSLESS FERRULE (Expanding)

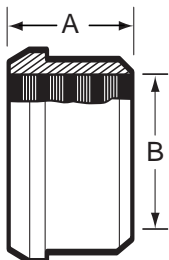

Size Tube OD	T304	T316L
1	\$10.20	\$13.60
1 1/2	\$10.20	\$13.60
2	\$13.38	\$17.82
2 1/2	\$17.18	\$36.11
3	\$21.82	\$39.70
4	\$34.29	\$83.20

14A - PLAIN WELDING FERRULE

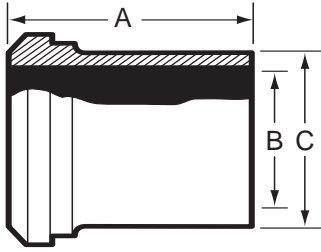

Size Tube OD	T304	T316L
1	\$9.71	\$17.10
1 1/2	\$11.11	\$16.60
2	\$12.10	\$19.40
2 1/2	\$19.50	\$30.00
3	\$24.70	\$39.60
4	\$42.80	\$68.60

14PR - SHORT PLAIN WELDING FERRULE

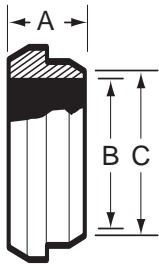

Size Tube OD	T304	T316L
1	\$6.60	\$12.50
1 1/2	\$7.11	\$11.60
2	\$9.00	\$16.20
2 1/2	\$15.02	\$29.50
3	\$19.47	\$37.30
4	\$30.69	\$63.60

14W - TANK WELDING PLAIN FERRULE

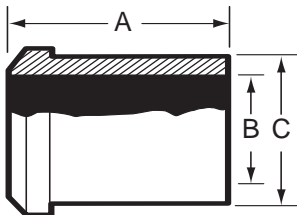

Size Tube OD	T304	T316L
1	\$63.33	\$84.44
1 1/2	\$55.33	\$91.11
2	\$65.33	\$106.67
2 1/2	\$111.11	\$193.00
3	\$137.78	\$225.00
4	\$166.67	\$248.00

14WL - LONG PLAIN WELDING FERRULE

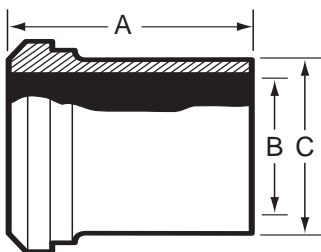

Size Tube OD	T304	T316L
1	\$51.78	\$60.89
1 1/2	\$53.33	\$64.00
2	\$60.00	\$67.33
2 1/2	\$66.67	\$82.10
3	\$73.70	\$110.00
4	\$111.00	\$165.00

15 - THREADED RECESSED FERRULE

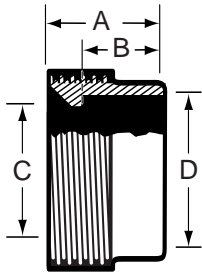

Size Tube OD	T304	T316L
1	N/A	\$58.29
1 1/2	N/A	\$54.27
2	N/A	\$85.80
2 1/2	N/A	\$122.46
3	N/A	\$177.51
4	N/A	\$263.58

15A - THREADED WELDING FERRULE

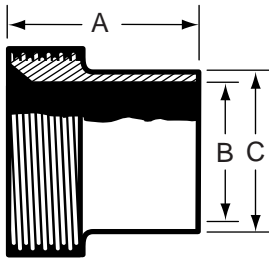

Size Tube OD	T304	T316L
1	\$13.00	\$35.10
1 1/2	\$18.33	\$32.10
2	\$20.90	\$35.30
2 1/2	\$31.33	\$65.80
3	\$41.22	\$82.00
4	\$61.07	\$174.00

15R - THREADED RECESSLESS FERRULE (Expanding)

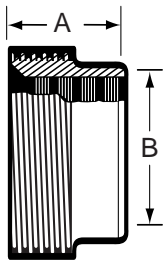

Size Tube OD	T304	T316L
1	\$13.30	\$44.33
1 1/2	\$14.56	\$48.67
2	\$18.20	\$59.42
2 1/2	\$24.84	\$82.89
3	\$29.36	\$104.00
4	\$46.60	\$155.33

15TR - SHORT THREADED WELDING FERRULE

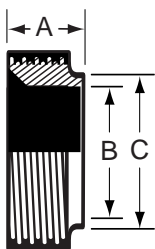

Size Tube OD	T304	T316L
1	\$8.33	\$19.22
1 1/2	\$8.33	\$17.51
2	\$11.50	\$29.71
2 1/2	\$17.71	\$41.22
3	\$22.60	\$58.86
4	\$36.00	\$121.38

15W - TANK WELDING FERRULE

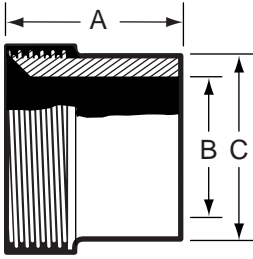

Size Tube OD	T304	T316L
1	\$41.10	\$57.10
1 1/2	\$38.90	\$57.11
2	\$55.70	\$82.50
2 1/2	\$81.10	\$122.00
3	\$91.10	\$136.00
4	\$168.00	\$207.00

15WL - LONG WELDING FERRULE

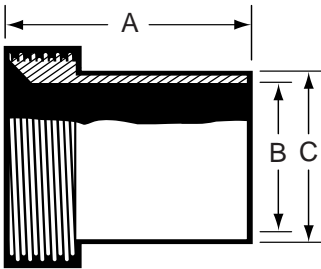

Size Tube OD	T304	T316L
1	\$37.90	\$46.60
1 1/2	\$37.91	\$46.60
2	\$44.90	\$66.80
2 1/2	\$64.20	\$95.50
3	\$83.80	\$125.00
4	\$124.00	\$188.00

16A - PLAIN CAP



Size Tube OD	T304	T316L
1	\$5.04	\$13.50
1 1/2	\$8.22	\$13.20
2	\$11.50	\$20.50
2 1/2	\$16.31	\$32.50
3	\$22.90	\$37.80
4	\$42.80	\$55.50

23B - TAPPED THERMOMETER CAP

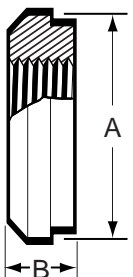

Size Tube OD	T304	T316L
1	\$33.90	\$87.22
1 1/2	\$33.90	\$84.56
2	\$55.40	\$140.96
2 1/2	\$69.20	\$174.96
3	\$115.00	\$291.60
4	\$213.00	\$368.22

14AHR - RUBBER HOSE ADAPTER

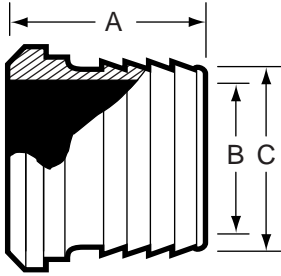

Size Tube OD	T304	T316L
1	\$55.00	\$96.11
1 1/2	\$55.30	\$96.11
2	\$80.00	\$136.16
2 1/2	\$128.00	\$192.25
3	\$147.00	\$312.35
4	\$167.00	\$560.69

14AHT - TYGON HOSE ADAPTER

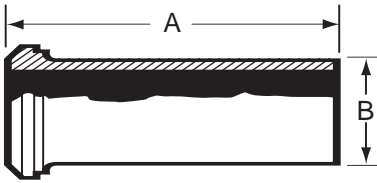

Size Tube OD	T304	T316L
1	\$31.10	\$120.13
1 1/2	\$31.11	\$120.13
2	\$40.70	\$143.05
2 1/2	\$60.90	\$200.22
3	\$75.50	\$246.00
4	\$101.00	\$411.93

15AHR - THREADED RUBBER HOSE ADAPTER

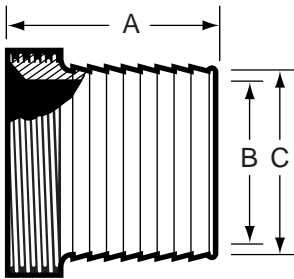

Size Tube OD	T304	T316L
1	\$80.90	\$174.80
1 1/2	\$80.91	\$172.20
2	\$88.80	\$238.40
2 1/2	\$117.00	\$333.78
3	\$142.00	\$381.40
4	\$175.00	\$456.87

15AHT - THREADED TYGON HOSE ADAPTER

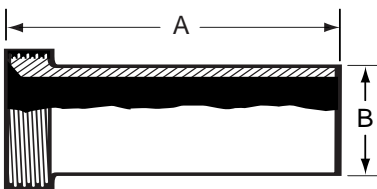

Size Tube OD	T304	T316L
1	\$51.20	\$63.89
1 1/2	\$51.20	\$63.89
2	\$62.02	\$68.67
2 1/2	\$92.49	\$94.78
3	\$114.58	\$118.89
4	\$159.00	\$182.22

BEVEL SEAT FITTINGS

14-22 - ADAPTER 13H NUT X FNPT

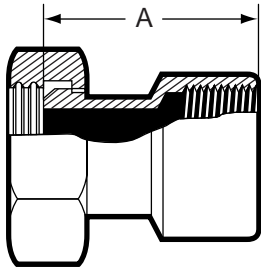

Size Tube OD	T304	T316L
1	\$111.11	\$157.78
1 1/2	\$111.11	\$157.78
2	\$124.44	\$204.44
2 1/2	\$202.22	\$266.67
3	\$268.89	\$430.00
4	\$413.33	\$522.22

14-19 - ADAPTER 13H NUT X MNPT

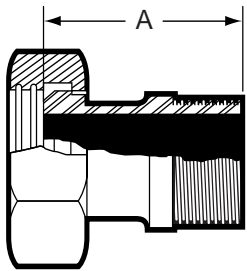

Size Tube OD	T304	T316L
1	\$108.89	\$130.00
1 1/2	\$108.89	\$136.67
2	\$131.11	\$161.11
2 1/2	\$210.00	\$235.56
3	\$255.56	\$301.11
4	\$317.78	\$423.33

21 - ADAPTER ACME THREAD X MNPT

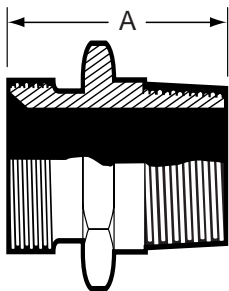

Size Tube OD	T304	T316L
1	\$71.22	\$102.00
1 1/2	\$71.22	\$102.00
2	\$94.22	\$142.22
2 1/2	\$181.11	\$263.33
3	\$190.00	\$281.11
4	\$237.78	\$356.67

22 - ADAPTER ACME THREAD X FNPT

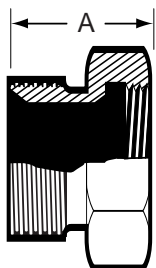

Size Tube OD	T304	T316L
1	\$76.11	\$105.51
1 1/2	\$76.11	\$105.51
2	\$101.00	\$157.78
2 1/2	\$190.00	\$271.11
3	\$208.89	\$290.00
4	\$243.33	\$360.00

BEVEL SEAT FITTINGS

31-14F - CONCENTRIC REDUCER 13H X 13H

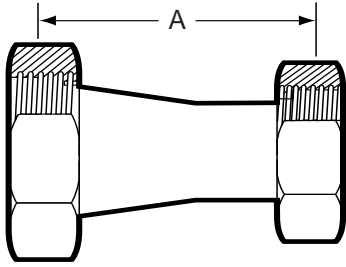

Size Tube OD	T304	T316L
1 1/2 X 1	\$100.00	\$107.58
2 X 1	\$136.11	\$140.29
2 X 1 1/2	\$117.00	\$126.49
2 1/2 X 1 1/2	\$172.44	\$166.60
2 1/2 X 2	\$150.44	\$162.62
3 X 2	\$185.44	\$207.11
3 X 2 1/2	\$183.33	\$199.44
4 X 2 1/2	\$423.89	\$433.33
4 X 3	\$263.89	\$272.22

31-15F - CONCENTRIC REDUCER PLAIN BEVEL X THREAD

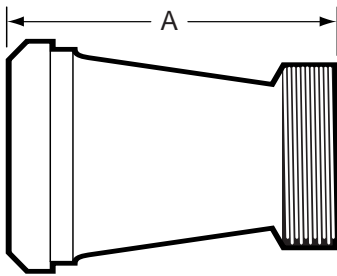

Size Tube OD	T304	T316L
1 1/2 X 1	\$80.78	\$95.89
2 X 1	\$124.33	\$136.33
2 X 1 1/2	\$104.33	\$108.11
2 1/2 X 1 1/2	\$142.89	\$145.33
2 1/2 X 2	\$125.67	\$132.33
3 X 2	\$157.67	\$169.98
3 X 2 1/2	\$160.67	\$174.89
4 X 2 1/2	\$365.67	\$377.78
4 X 3	\$231.11	\$246.67

31TT - CONCENTRIC REDUCER THREAD X THREAD

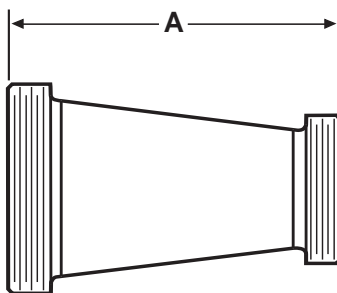

Size Tube OD	T304	T316L
1 1/2 X 1	\$80.44	\$89.38
2 X 1	\$120.22	\$119.47
2 X 1 1/2	\$90.89	\$104.62
2 1/2 X 1 1/2	\$143.44	\$148.11
2 1/2 X 2	\$121.44	\$138.71
3 X 2	\$197.56	\$200.56
3 X 2 1/2	\$195.33	\$189.53
4 X 2 1/2	\$323.89	\$356.45
4 X 3	\$204.44	\$216.67

31TP - CONCENTRIC REDUCER THREAD X 13H NUT

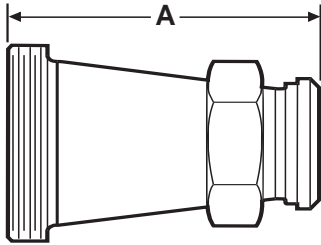

Size Tube OD	T304	T316L
1 1/2 X 1	\$83.22	\$99.40
2 X 1	\$124.56	\$129.49
2 X 1 1/2	\$109.40	\$112.22
2 1/2 X 1 1/2	\$146.11	\$149.80
2 1/2 X 2	\$124.22	\$135.11
3 X 2	\$198.00	\$202.22
3 X 2 1/2	\$196.67	\$200.56
4 X 2	\$330.22	\$333.33
4 X 2 1/2	\$330.22	\$344.44
4 X 3	\$210.09	\$222.22

32-14F - ECCENTRIC REDUCER 13H NUT X 13H NUT

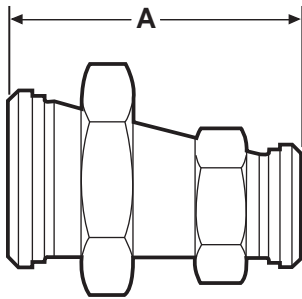

Size Tube OD	T304	T316L
1 1/2 X 1	\$132.78	\$145.22
2 X 1	\$202.67	\$243.00
2 X 1 1/2	\$141.89	\$149.00
2 1/2 X 1 1/2	\$183.78	\$232.89
2 1/2 X 2	\$159.76	\$162.22
3 X 2	\$207.78	\$251.44
3 X 2 1/2	\$179.22	\$200.33
4 X 2	\$320.78	\$412.44
4 X 2 1/2	\$345.44	\$436.38
4 X 3	\$271.22	\$300.00

32-15F - ECCENTRIC REDUCER PLAIN BEVEL X THREAD

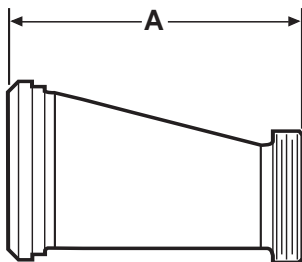

Size Tube OD	T304	T316L
1 1/2 X 1	\$127.56	\$138.78
2 X 1	\$191.00	\$231.89
2 X 1 1/2	\$130.22	\$144.44
2 1/2 X 1 1/2	\$164.56	\$206.00
2 1/2 X 2	\$138.44	\$177.78
3 X 2	\$186.87	\$215.33
3 X 2 1/2	\$163.44	\$183.33
4 X 2	\$267.67	\$351.00
4 X 2 1/2	\$288.89	\$300.00
4 X 3	\$248.56	\$262.67

32TT - ECCENTRIC REDUCER THREAD X THREAD

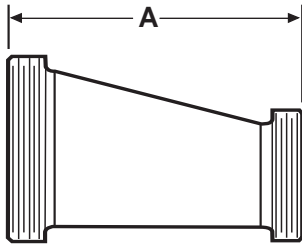

Size Tube OD	T304	T316L
1 1/2 X 1	\$120.33	\$124.11
2 X 1	\$186.89	\$216.22
2 X 1 1/2	\$127.00	\$131.11
2 1/2 X 1 1/2	\$165.11	\$211.56
2 1/2 X 2	\$141.11	\$150.00
3 X 2	\$226.78	\$235.00
3 X 2 1/2	\$198.11	\$205.56
4 X 2	\$231.11	\$361.22
4 X 2 1/2	\$253.44	\$306.33
4 X 3	\$211.11	\$235.33

32TP - ECCENTRIC REDUCER THREAD X 13H NUT

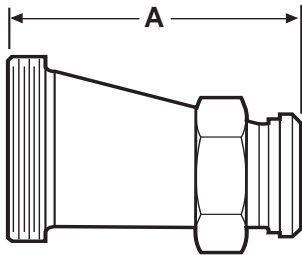

Size Tube OD	T304	T316L
1 1/2 X 1	\$123.11	\$129.78
2 X 1	\$191.33	\$220.11
2 X 1 1/2	\$129.56	\$133.11
2 1/2 X 1 1/2	\$161.33	\$208.78
2 1/2 X 2	\$143.78	\$147.89
3 X 2	\$204.33	\$205.89
3 X 2 1/2	\$182.33	\$188.89
4 X 2	\$241.89	\$338.89
4 X 2 1/2	\$282.00	\$306.44
4 X 3	\$220.00	\$235.67

JOHN PERRY

14PRJP - SHORT PLAIN WELDING FERRULE

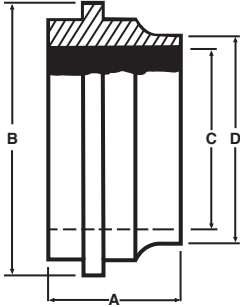

Size Tube OD	T304	T316L
1	N/A	\$26.15
1 1/2	N/A	\$19.66
2	N/A	\$33.00
2 1/2	N/A	\$53.42
3	N/A	\$59.91
4	N/A	\$140.85

15TRJP - SHORT THREAD WELDING FERRULE

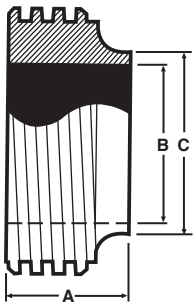

Size Tube OD	T304	T316L
1	N/A	\$32.49
1 1/2	N/A	\$32.49
2	N/A	\$46.71
2 1/2	N/A	\$86.19
3	N/A	\$93.55
4	N/A	\$200.76

14AJP - LONG PLAIN WELDING FERRULE

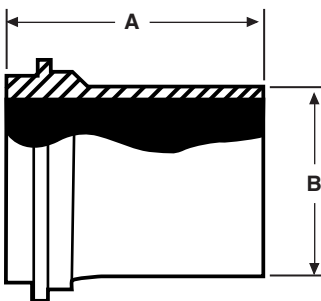

Size Tube OD	T304	T316L
1	N/A	\$43.20
1 1/2	N/A	\$43.20
2	N/A	\$49.09
2 1/2	N/A	\$70.09
3	N/A	\$105.71
4	N/A	\$242.96

JOHN PERRY

15AJP - LONG THREAD WELDING FERRULE

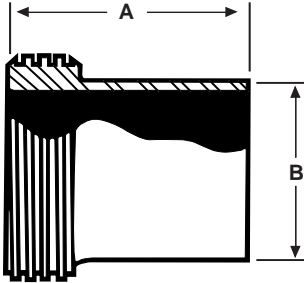

Size Tube OD	T304	T316L
1	N/A	\$67.75
1 1/2	N/A	\$67.75
2	N/A	\$74.53
2 1/2	N/A	\$139.00
3	N/A	\$172.87
4	N/A	\$367.20

16AJP - CAP

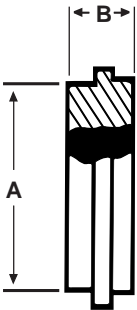

Size Tube OD	T304	T316L
1	N/A	\$16.51
1 1/2	N/A	\$20.78
2	N/A	\$28.51
2 1/2	N/A	\$37.29
3	N/A	\$54.65
4	N/A	\$130.51

FITTINGS



E-Line Fittings



E-LINE FITTINGS....

E-Line Fittings have a male and female interface construction to ensure rigidity of your system.

VNE offers E-Line Fittings in sizes 1" through 6" in T304 and T316L material. VNE offers Polished ID and OD Fittings for immediate shipment. Other polished combinations may be ordered.

Gaskets for E-Line Fittings are available in several different materials, Buna-N, EPDM, Teflon®, and Viton®.

E-LINE FITTING SPECIFICATIONS....

Size Range: 1" OD through 6" OD

Materials: T304
T316L

Finish: No. 7 - ID & OD
No. 5 - OD only
No. 3 - ID only
No. 1 - unpolished

ORDERING SPECIFICATIONS....

Specify:

- Quantity
- Product description or Part No.
- Size
- Material Type
- Polish Requirements

LIMITED WARRANTY....

VNE Corporation products are warranted to be free from defects in material and workmanship for a period of one year from the date of shipment. Any product that proves to be defective shall be repaired or replaced at the option of VNE, providing it has been used as recommended and in strict accordance with recognized piping practices, and that has not been subject to extraordinary service, such as encountered under severe corrosive or abrasive conditions.

VNE makes no warranties, express or implied, other than those listed above.

VNE shall not be liable for any consequential, indirect, incidental or contingent damages.

VNE CORPORATION

P.O. Box 1698 • 1149 Barberry Drive • Janesville, WI 53547

TEL: 608-756-4930 • FAX: 608-756-3643 • 1-800-356-1111 • Web site: vnestainless.com

E-LINE TYPE

VNE	ROBERT JAMES	ANDRON	WAUKESHA	G & H
E2CI	RJ2CZ	----	2CI	HDI-2C
E2FI	RJ2FZ	----	2FI	HDI-2F
E2EI	----	----	2EI	HDI-2E
E2KI	RJ2KZ	----	2KI	HDI-2K
E2PI	RJ2PZ	----	2PI	HDI-2P
E7I	RJ7Z	----	7I	HDI-7
E7AI	RJ7AZ	----	7AI	----
E7EI	RJ7EZ	----	7EI	----
E7BI	RJ7BZ	----	7BI	----
E9I	RJ9Z	----	9I	----
E13IS	RJ13ZS	----	13IS	HDI-13-UD
E13IU	RJ13Z	----	13IU	HDI-13-U
E14WI	RJ14WZ	AY14WI	14WI	14WH
E15WI	RJ15WZ	AY15WI	15WI	15WH
E14WLI	RJ14WLZ	AY14WLI	14WLI	14WLH
E15WLI	RJ15WLZ	AY15WLI	15WLI	15WLH
E14HRI	RJ14HRZ	AY14AHR	14HRI	----
E14HTI	RJ14HTZ	AY14AHT	14HTI	----
E15HRI	RJ15HRZ	AY15AHR	15HRI	----
E15HTI	RJ15HTZ	AY15AHT	15HTI	----
E17-14I-15I	RJ17-14Z-15Z	----	17-14I-15I	----
E17-15I-15I	RJ17-15Z-15Z	----	17-15I-15I	----
E17-14I-14I	RJ17-14Z-14Z	----	17-14I-14I	----
E17-14I-14	RJ17-14Z-14	----	17-14I-14	----
E17-14I-14MP	RJ17-14Z-14MP	----	17-14I-14MP	----
E17-14I-15	RJ17-14Z-15	----	17-14I-15	----
E17-15I-14	RJ17-15Z-14	----	17-15I-14	----
E17-15I-15	RJ17-15Z-15	----	17-15I-15I	----
E17-15I-14MP	RJ17-15Z-14MP	----	17-15I-14MP	----
E21I-14I	RJ21-14Z	----	21FI-14I	----
E21I-15I	RJ21-15Z	----	21F1-15I	----
E22I-14I	RJ22-14Z	----	22FI-14I	----
E22I-15I	RJ22-15Z	----	22FI-15I	----
E16AI-14I	RJ16AZ-14Z	AY16AI-14I	16AI-14I	HDI-16A-14
E16AI-15I	RJ16AZ-15Z	AY16AI-15I	16AI-15I	HDI-16A-15
E31I-14I	RJ31Z-14Z	----	31I-14FI	HDI-31-14F
E31I-15I	RJ31Z-15Z	----	31I-15FI	HDI-31-15F
E31I-15I-14I	RJ31Z-15Z-14Z	----	----	----
E31I-15I-15I	RJ31Z-15Z-15Z	----	----	----
E32I-14I	RJ32Z-14Z	----	32I-14FI	HDI-32-14F
E32I-15I	RJ32Z-15Z	----	32I-15FI	HDI-32-15F

E2CI - 90° ELBOW FEMALE X FEMALE

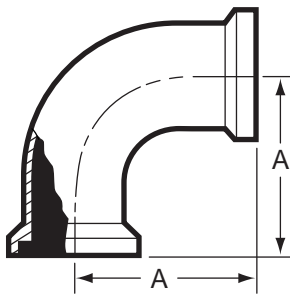

Size Tube OD	T304	T316L
1	\$79.33	\$99.11
1 1/2	\$100.40	\$108.89
2	\$118.00	\$126.78
2 1/2	\$159.44	\$187.56
3	\$185.89	\$312.89
4	\$297.11	\$382.11
6	\$1,277.78	\$1,532.44

E2FI - 90° ELBOW MALE X FEMALE

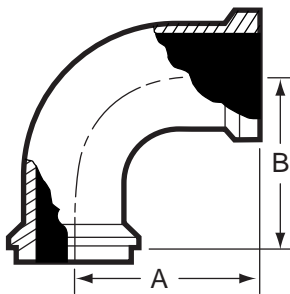

Size Tube OD	T304	T316L
1	\$79.33	\$99.11
1 1/2	\$100.40	\$108.89
2	\$118.00	\$126.78
2 1/2	\$159.44	\$187.56
3	\$185.89	\$312.89
4	\$297.11	\$382.11
6	\$1,277.78	\$1,532.44

E2EI - 90° ELBOW MALE X MALE

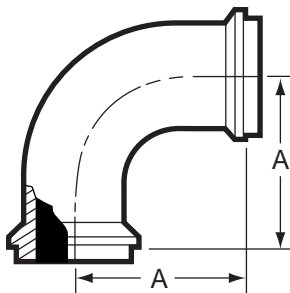

Size Tube OD	T304	T316L
1	\$79.33	\$99.11
1 1/2	\$100.40	\$108.89
2	\$118.00	\$126.78
2 1/2	\$159.44	\$187.56
3	\$185.89	\$312.89
4	\$297.11	\$382.11
6	\$1,277.78	\$1,532.44

E2KI - 45° ELBOW FEMALE X FEMALE

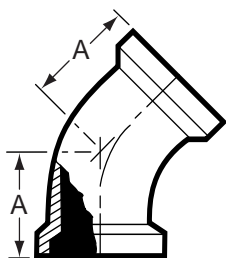

Size Tube OD	T304	T316L
1	\$67.44	\$81.33
1 1/2	\$97.44	\$102.11
2	\$123.89	\$134.89
2 1/2	\$173.11	\$195.33
3	\$202.22	\$326.67
4	\$254.13	\$358.22
6	\$1,195.11	\$1,348.44

E2PI - 45° ELBOW FEMALE X MALE

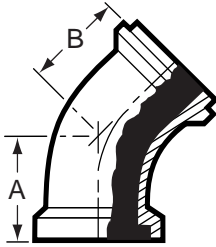

Size Tube OD	T304	T316L
1	\$67.44	\$81.33
1 1/2	\$97.44	\$102.11
2	\$123.89	\$134.89
2 1/2	\$173.11	\$195.33
3	\$202.22	\$326.67
4	\$254.13	\$358.22
6	\$1,195.11	\$1,348.44

E2HI - 45° ELBOW MALE X MALE

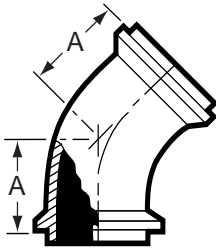

Size Tube OD	T304	T316L
1	\$67.44	\$81.33
1 1/2	\$97.44	\$102.11
2	\$123.89	\$134.89
2 1/2	\$173.11	\$195.33
3	\$202.22	\$326.67
4	\$254.13	\$358.22
6	\$1,195.11	\$1,348.44

E7I - TEE ALL ENDS FEMALE

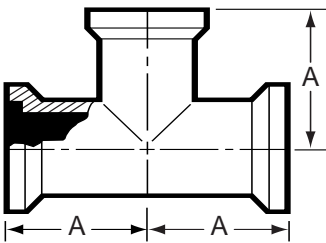

Size Tube OD	T304	T316L
1	\$119.22	\$134.00
1 1/2	\$141.00	\$146.11
2	\$168.89	\$189.67
2 1/2	\$225.33	\$272.89
3	\$257.44	\$446.67
4	\$379.44	\$471.44
6	\$1,964.67	\$2,038.22

E7AI - TEE FEMALE X FEMALE X MALE

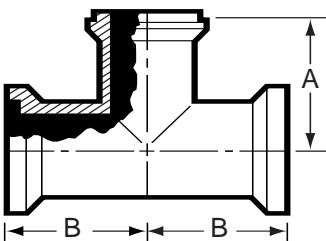

Size Tube OD	T304	T316L
1	\$119.22	\$134.00
1 1/2	\$141.00	\$146.11
2	\$168.89	\$189.67
2 1/2	\$225.33	\$272.89
3	\$257.44	\$446.67
4	\$379.44	\$471.44
6	\$1,964.67	\$2,038.22

E7BI - TEE MALE X FEMALE X FEMALE

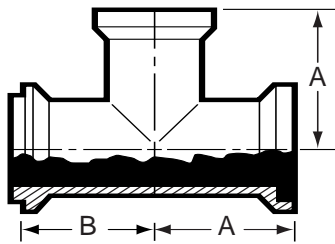

Size Tube OD	T304	T316L
1	\$119.22	\$134.00
1 1/2	\$141.00	\$146.11
2	\$168.89	\$189.67
2 1/2	\$225.33	\$272.89
3	\$257.44	\$446.67
4	\$379.44	\$471.44
6	\$1,964.67	\$2,038.22

E7EI - TEE MALE X MALE X FEMALE

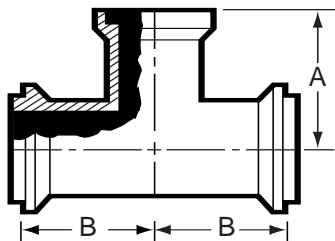

Size Tube OD	T304	T316L
1	\$119.22	\$134.00
1 1/2	\$141.00	\$146.11
2	\$168.89	\$189.67
2 1/2	\$225.33	\$272.89
3	\$257.44	\$446.67
4	\$379.44	\$471.44
6	\$1,964.67	\$2,038.22

E7HI - TEE ALL ENDS MALE

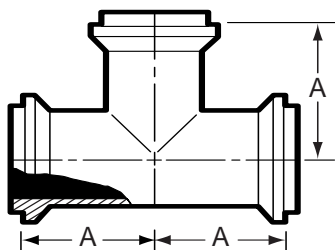

Size Tube OD	T304	T316L
1	\$119.22	\$134.00
1 1/2	\$141.00	\$146.11
2	\$168.89	\$189.67
2 1/2	\$225.33	\$272.89
3	\$257.44	\$446.67
4	\$379.44	\$471.44
6	\$1,964.67	\$2,038.22

E7RI - REDUCING TEE ALL ENDS FEMALE

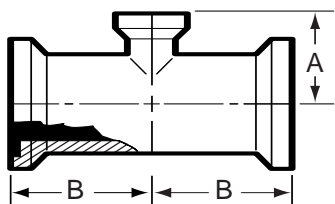

Size Tube OD	T304	T316L
1 1/2 X 1	\$158.33	\$156.67
2 X 1	\$185.44	\$198.22
2 X 1 1/2	\$196.44	\$211.67
2 1/2 X 1 1/2	\$294.44	\$297.89
2 1/2 X 2	\$244.89	\$267.89
3 X 2	\$348.00	\$477.00
3 X 2 1/2	\$341.00	\$467.00
4 X 2	\$688.89	\$933.33
4 X 2 1/2	\$668.00	\$918.00
4 X 3	\$682.00	\$936.00
6 X 3	\$1,668.33	\$1,857.44
6 X 4	\$1,955.56	\$2,000.00

E9I - CROSS ALL ENDS FEMALE

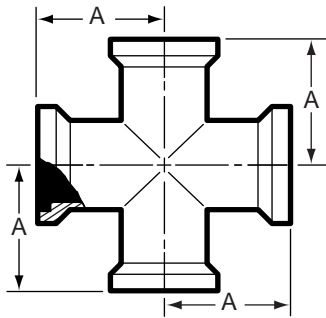

Size Tube OD	T304	T316L
1	\$186.67	\$277.78
1 1/2	\$220.00	\$286.67
2	\$243.33	\$363.78
2 1/2	\$289.89	\$493.33
3	\$362.22	\$719.22
4	\$660.00	\$1111.11
6	\$2,222.22	\$2,817.78

E14WI - SHORT MALE WELDING FERRULE

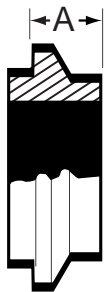

Size Tube OD	T304	T316L
1	\$7.33	\$8.70
1 1/2	\$7.33	\$8.70
2	\$11.31	\$13.80
2 1/2	\$17.78	\$23.22
3	\$26.51	\$36.70
4	\$43.31	\$61.13
6	\$182.00	\$200.45

E14WLI - LONG MALE WELDING FERRULE

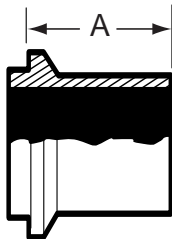

Size Tube OD	T304	T316L
1	\$47.89	\$53.33
1 1/2	\$49.56	\$55.00
2	\$55.89	\$62.22
2 1/2	\$59.11	\$75.00
3	\$78.89	\$100.78
4	\$120.00	\$153.33
6	\$845.05	\$833.33

E15WI - SHORT FEMALE WELDING FERRULE



Size Tube OD	T304	T316L
1	\$7.89	\$10.20
1 1/2	\$7.89	\$10.40
2	\$13.22	\$16.30
2 1/2	\$18.80	\$26.00
3	\$27.96	\$38.64
4	\$43.31	\$61.13
6	T316L	\$217.78

E15WLI - LONG FEMALE WELDING FERRULE



Size Tube OD	T304	T316L
1	\$46.67	\$51.56
1 1/2	\$51.67	\$57.44
2	\$53.33	\$64.44
2 1/2	\$70.78	\$80.44
3	\$85.00	\$107.78
4	\$132.22	\$168.89
6	\$844.44	\$944.44

E14HRI - MALE RUBBER HOSE ADAPTER

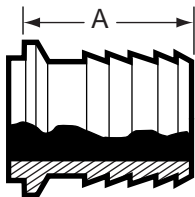

Size Tube OD	T304	T316L
1	\$55.56	\$82.90
1 1/2	\$57.00	\$82.90
2	\$68.33	\$112.22
2 1/2	\$88.33	\$145.56
3	\$125.56	\$206.67
4	\$213.00	\$395.56
6	\$677.78	\$722.22

E14HTI - MALE TYGON HOSE ADAPTER

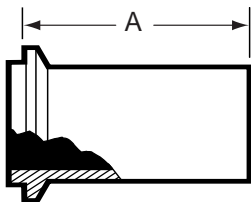

Size Tube OD	T304	T316L
1	\$54.89	\$61.11
1 1/2	\$56.22	\$62.44
2	\$62.33	\$69.22
2 1/2	\$76.44	\$103.00
3	\$82.44	\$121.11
4	\$117.78	\$192.22

E15HRI - FEMALE RUBBER HOSE ADAPTER

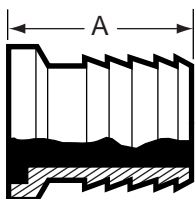

Size Tube OD	T304	T316L
1	\$59.00	\$97.11
1 1/2	\$59.00	\$97.11
2	\$78.33	\$130.00
2 1/2	\$102.56	\$168.89
3	\$146.67	\$238.89
4	\$274.44	\$390.00
6	\$677.78	\$722.22

E15HTI - FEMALE TYGON HOSE ADAPTER

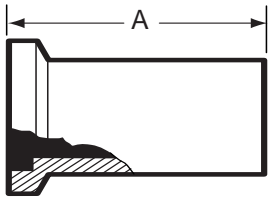

Size Tube OD	T304	T316L
1	\$57.22	\$63.56
1 1/2	\$58.56	\$65.11
2	\$64.67	\$84.00
2 1/2	\$78.56	\$114.44
3	\$87.11	\$145.56
4	\$140.00	\$195.56

E14WHI - MALE WELD FERRULE

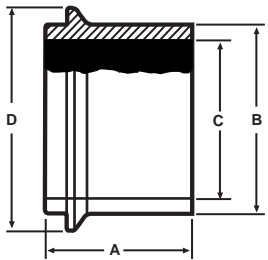

Size Tube OD	T304	T316L
1	N/A	\$63.56
1 1/2	N/A	\$63.56
2	N/A	\$69.11
2 1/2	N/A	\$116.67
3	N/A	\$126.89
4	N/A	\$155.11

E15WHI - FEMALE WELD FERRULE

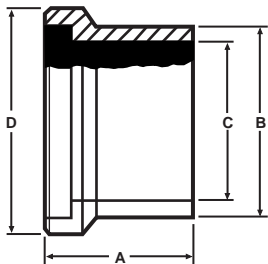

Size Tube OD	T304	T316L
1	N/A	\$66.89
1 1/2	N/A	\$66.89
2	N/A	\$77.33
2 1/2	N/A	\$125.33
3	N/A	\$139.33
4	N/A	\$168.44

E17-14I-14I - ADAPTER BOTH ENDS MALE

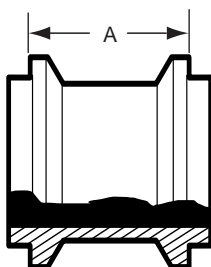

Size Tube OD	T304	T316L
1	\$60.22	\$102.56
1 1/2	\$60.22	\$102.56
2	\$80.11	\$132.22
2 1/2	\$111.00	\$183.33
3	\$244.44	\$377.78
4	\$290.00	\$477.78
6	\$777.78	\$844.44

E17-14I-15I - ADAPTER MALE X FEMALE

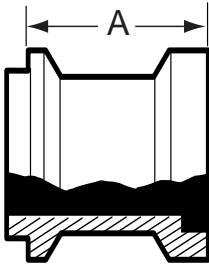

Size Tube OD	T304	T316L
1	\$60.22	\$102.56
1 1/2	\$60.22	\$102.56
2	\$80.11	\$132.22
2 1/2	\$111.00	\$183.33
3	\$244.44	\$400.00
4	\$290.00	\$477.78
6	\$777.78	\$844.44

E17-15I-15I - ADAPTER BOTH ENDS FEMALE

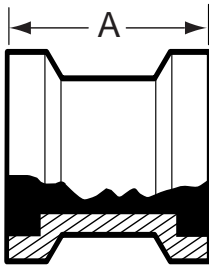

Size Tube OD	T304	T316L
1	\$60.22	\$102.56
1 1/2	\$60.22	\$102.56
2	\$80.11	\$132.22
2 1/2	\$111.00	\$183.33
3	\$244.44	\$400.00
4	\$290.00	\$477.78
6	\$777.78	\$844.44

E17-14I-14-ADAPTER MALE X 13H NUT

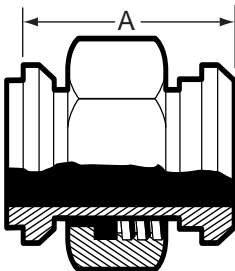

Size Tube OD	T304	T316L
1	\$87.33	\$160.00
1 1/2	\$87.33	\$160.00
2	\$126.67	\$207.78
2 1/2	\$176.67	\$288.89
3	\$232.22	\$381.11
4	\$366.67	\$602.22

E17-14I-14MP - ADAPTER MALE X CLAMP

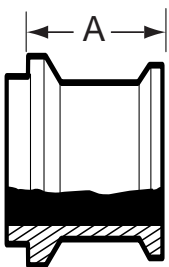

Size Tube OD	T304	T316L
1	\$53.11	\$97.00
1 1/2	\$53.11	\$101.67
2	\$71.44	\$117.78
2 1/2	\$98.11	\$150.00
3	\$126.67	\$204.44
4	\$215.56	\$477.78
6	\$488.89	\$800.00

E17-14I-15 - ADAPTER MALE X ACME THREAD

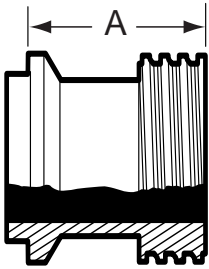

Size Tube OD	T304	T316L
1	\$58.11	\$96.11
1 1/2	\$58.11	\$96.11
2	\$76.56	\$127.78
2 1/2	\$102.67	\$175.56
3	\$126.67	\$206.67
4	\$291.11	\$477.78

E17-15I-14 - ADAPTER FEMALE X 13H NUT

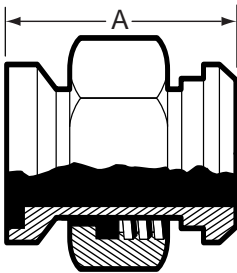

Size Tube OD	T304	T316L
1	\$97.11	\$160.00
1 1/2	\$97.11	\$160.00
2	\$126.67	\$207.78
2 1/2	\$180.00	\$295.56
3	\$238.89	\$381.11
4	\$376.67	\$602.22

E17-15I-14MP - ADAPTER FEMALE X CLAMP

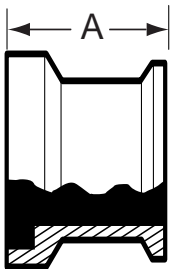

Size Tube OD	T304	T316L
1	\$54.89	\$97.00
1 1/2	\$54.89	\$97.00
2	\$71.44	\$113.33
2 1/2	\$101.22	\$150.00
3	\$126.67	\$204.44
4	\$213.33	\$477.78
6	\$488.89	\$577.78

E17-15I-15 - ADAPTER FEMALE X ACME THREAD

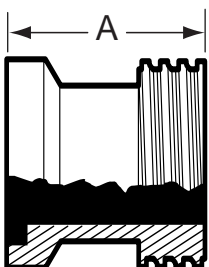

Size Tube OD	T304	T316L
1	\$60.22	\$102.56
1 1/2	\$60.22	\$102.56
2	\$80.11	\$132.22
2 1/2	\$111.00	\$183.33
3	\$244.44	\$400.00
4	\$290.00	\$477.78

E211-14I - ADAPTER MALE X MNPT

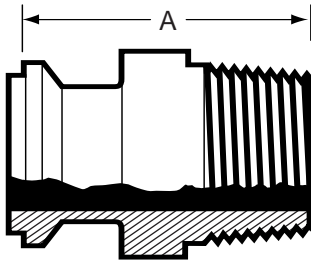

Size Tube OD	T304	T316L
1	\$77.33	\$128.89
1 1/2	\$99.89	\$164.44
2	\$150.00	\$186.67
2 1/2	\$195.56	\$244.44
3	\$253.33	\$320.00
4	\$313.33	\$413.33
6	POA	POA

E211-15I - ADAPTER FEMALE X MNPT

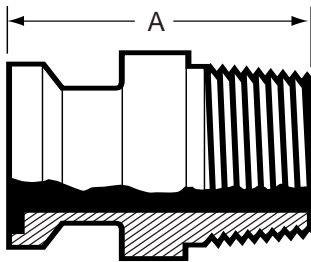

Size Tube OD	T304	T316L
1	\$79.00	\$142.22
1 1/2	\$101.33	\$166.67
2	\$116.67	\$187.78
2 1/2	\$154.44	\$245.56
3	\$201.11	\$414.44
4	\$262.22	\$513.33
6	POA	POA

E221-14I - ADAPTER MALE X FNPT

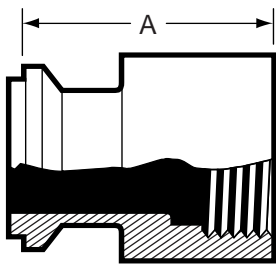

Size Tube OD	T304	T316L
1	\$88.89	\$146.67
1 1/2	\$101.33	\$166.67
2	\$115.56	\$192.22
2 1/2	\$201.11	\$325.56
3	\$260.00	\$425.56
4	\$337.78	\$524.44

E221-15I - ADAPTER FEMALE X FNPT

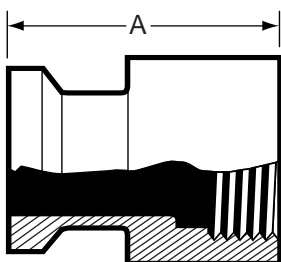

Size Tube OD	T304	T316L
1	\$88.89	\$146.67
1 1/2	\$99.89	\$166.67
2	\$112.22	\$187.78
2 1/2	\$195.56	\$320.00
3	\$253.33	\$414.44
4	\$313.33	\$513.33

E23BI - THERMOMETER CAP

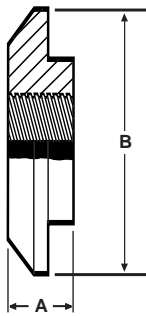

Size Tube OD	T304	T316L
1	\$34.89	\$50.00
1 1/2	\$34.89	\$50.00
2	\$50.33	\$72.56
2 1/2	\$57.11	\$79.78
3	\$94.00	\$135.56
4	\$136.67	\$177.78

E28AI - LATERAL ALL ENDS FEMALE

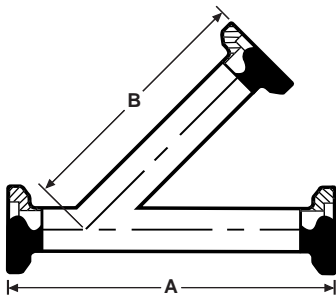

Size Tube OD	T304	T316L
1	\$305.56	\$386.98
1 1/2	\$305.56	\$386.98
2	\$361.11	\$433.33
2 1/2	\$416.67	\$574.22
3	\$505.56	\$671.84
4	\$816.67	\$1142.78
6	\$2,222.22	\$2,777.78

E28BI - TRUE Y ALL ENDS FEMALE

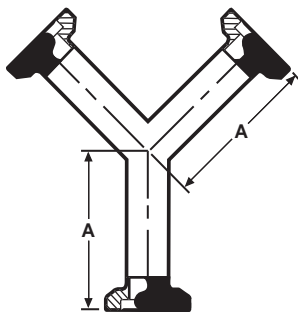

Size Tube OD	T304	T316L
1	\$305.56	\$401.71
1 1/2	\$305.56	\$401.71
2	\$361.11	\$433.33
2 1/2	\$416.67	\$576.04
3	\$505.56	\$667.33
4	\$816.67	\$1158.34
6	\$2,222.22	\$2,777.78

E16AI-14I - MALE END CAP



Size Tube OD	T304	T316L
1	\$11.12	\$31.96
1 1/2	\$11.12	\$31.96
2	\$17.56	\$46.56
2 1/2	\$26.45	\$73.58
3	\$33.34	\$94.60
4	\$60.00	\$170.58
6	\$555.56	\$666.67

E16AI-15I - FEMALE END CAP



Size Tube OD	T304	T316L
1	\$11.12	\$22.50
1 1/2	\$11.12	\$22.50
2	\$17.56	\$30.50
2 1/2	\$26.45	\$50.20
3	\$33.34	\$65.10
4	\$60.00	\$119.00
6	\$555.56	\$666.67

GASKETS



Size Tube OD	E40IH	E40IE	E40IT	E40IS	E40IV
1	\$0.67	\$2.67	\$1.33	\$6.89	\$5.33
1 1/2	\$0.67	\$2.56	\$1.44	\$6.89	\$4.89
2	\$0.78	\$2.89	\$1.56	\$8.11	\$6.00
2 1/2	\$0.89	\$3.11	\$1.78	\$8.66	\$6.89
3	\$1.00	\$3.89	\$2.22	\$12.11	\$8.67
4	\$1.56	\$5.56	\$2.89	\$13.22	\$11.33

E13IU - UNPOLISHED BOLTED CLAMP

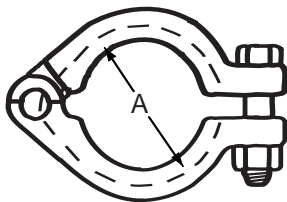

Size Tube OD	T304	T316L
1 & 1 1/2	\$14.67	N/A
2	\$21.89	N/A
2 1/2	\$28.00	N/A
3	\$34.45	N/A
4	\$50.45	N/A
6	\$101.36	N/A

E13IS - HEAVY DUTY CLAMP

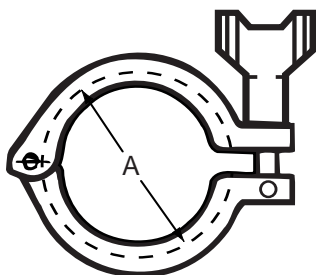

Size Tube OD	T304	T316L
1 & 1 1/2	\$17.91	N/A
2	\$22.23	N/A
2 1/2	\$31.31	N/A
3	\$37.56	N/A
4	\$44.23	N/A
6	\$91.12	N/A

E311-14I - CONCENTRIC REDUCER MALE X MALE

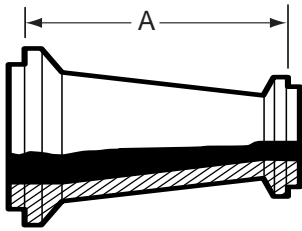

Size Tube OD	T304	T316L
1 1/2 X 1	\$93.89	\$155.56
2 X 1	\$124.44	\$177.78
2 X 1 1/2	\$105.33	\$145.56
2 1/2 X 1 1/2	\$150.00	\$182.22
2 1/2 X 2	\$127.89	\$175.56
3 X 1 1/2	\$200.00	\$277.78
3 X 2	\$166.44	\$248.89
3 x 2 1/2	\$164.22	\$235.56
4 X 2	\$286.67	\$342.22
4 x 2 1/2	\$273.33	\$328.89
4 x 3	\$262.22	\$317.78
6 x 3	\$822.22	\$840.00
6 x 4	\$866.67	\$888.89

E311-14I-15I - CONCENTRIC REDUCER MALE X FEMALE

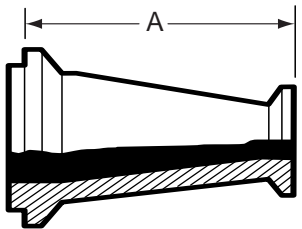

Size Tube OD	T304	T316L
1 1/2 X 1	\$93.89	\$155.56
2 X 1	\$124.44	\$177.78
2 X 1 1/2	\$105.33	\$145.56
2 1/2 X 1 1/2	\$150.00	\$182.22
2 1/2 X 2	\$127.89	\$175.56
3 X 1 1/2	\$200.00	\$277.78
3 X 2	\$166.44	\$248.89
3 x 2 1/2	\$164.22	\$235.56
4 X 2	\$286.67	\$342.22
4 x 2 1/2	\$273.33	\$328.89
4 x 3	\$262.22	\$317.78
6 x 3	\$822.22	\$840.00
6 x 4	\$866.67	\$888.89

E311-151-141 - CONCENTRIC REDUCER FEMALE X MALE

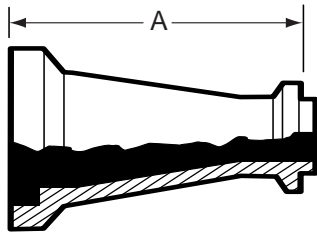

Size Tube OD	T304	T316L
1 1/2 X 1	\$93.89	\$155.56
2 X 1	\$124.44	\$177.78
2 X 1 1/2	\$105.33	\$145.56
2 1/2 X 1 1/2	\$150.00	\$182.22
2 1/2 X 2	\$127.89	\$175.56
3 X 1 1/2	\$200.00	\$277.78
3 X 2	\$166.44	\$248.89
3 x 2 1/2	\$164.22	\$235.56
4 X 2	\$286.67	\$342.22
4 x 2 1/2	\$273.33	\$328.89
4 x 3	\$262.22	\$317.78
6 x 3	\$822.22	\$840.00
6 x 4	\$866.67	\$888.89

E311-151 - CONCENTRIC REDUCER BOTH ENDS FEMALE

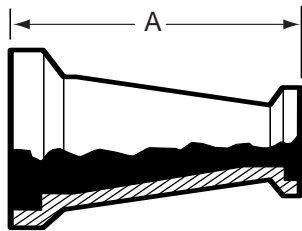

Size Tube OD	T304	T316L
1 1/2 X 1	\$93.89	\$155.56
2 X 1	\$124.44	\$177.78
2 X 1 1/2	\$105.33	\$145.56
2 1/2 X 1 1/2	\$150.00	\$182.22
2 1/2 X 2	\$127.89	\$175.56
3 X 1 1/2	\$200.00	\$277.78
3 X 2	\$166.44	\$248.89
3 x 2 1/2	\$164.22	\$235.56
4 X 2	\$286.67	\$342.22
4 x 2 1/2	\$273.33	\$328.89
4 x 3	\$262.22	\$317.78
6 x 3	\$822.22	\$840.00
6 x 4	\$866.67	\$888.89

E321-141 - ECCENTRIC REDUCER MALE X MALE

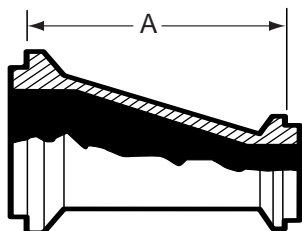

Size Tube OD	T304	T316L
1 1/2 X 1	\$119.89	\$185.56
2 X 1	\$191.00	\$227.22
2 X 1 1/2	\$131.22	\$156.11
2 1/2 X 1 1/2	\$171.56	\$229.33
2 1/2 X 2	\$147.56	\$202.22
3 X 1 1/2	\$193.33	\$294.44
3 X 2	\$188.89	\$255.56
3 x 2 1/2	\$167.11	\$244.44
4 X 2	\$305.56	\$412.00
4 x 2 1/2	\$300.00	\$333.33
4 x 3	\$244.78	\$326.67
6 x 3	\$844.44	\$933.33
6 x 4	\$888.89	\$944.44

E32I-14I-15I - ECCENTRIC REDUCER MALE X FEMALE

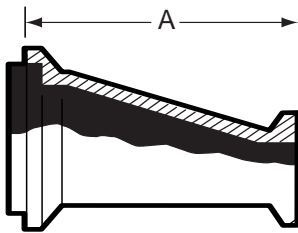

Size Tube OD	T304	T316L
1 1/2 X 1	\$119.89	\$185.56
2 X 1	\$191.00	\$227.22
2 X 1 1/2	\$131.22	\$156.11
2 1/2 X 1 1/2	\$171.56	\$229.33
2 1/2 X 2	\$147.56	\$202.22
3 X 1 1/2	\$193.33	\$294.44
3 X 2	\$188.89	\$255.56
3 x 2 1/2	\$167.11	\$244.44
4 X 2	\$305.56	\$412.00
4 x 2 1/2	\$300.00	\$333.33
4 x 3	\$244.78	\$326.67
6 x 3	\$844.44	\$933.33
6 x 4	\$888.89	\$944.44

E32I-15I-14I - ECCENTRIC REDUCER FEMALE X MALE

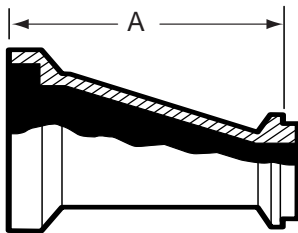

Size Tube OD	T304	T316L
1 1/2 X 1	\$119.89	\$185.56
2 X 1	\$191.00	\$227.22
2 X 1 1/2	\$131.22	\$156.11
2 1/2 X 1 1/2	\$171.56	\$229.33
2 1/2 X 2	\$147.56	\$202.22
3 X 1 1/2	\$193.33	\$294.44
3 X 2	\$188.89	\$255.56
3 x 2 1/2	\$167.11	\$244.44
4 X 2	\$305.56	\$412.00
4 x 2 1/2	\$300.00	\$333.33
4 x 3	\$244.78	\$326.67
6 x 3	\$844.44	\$933.33
6 x 4	\$888.89	\$944.44

E32I-15I - ECCENTRIC REDUCER BOTH ENDS FEMALE

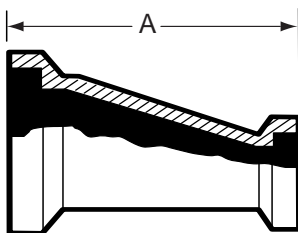

Size Tube OD	T304	T316L
1 1/2 X 1	\$119.89	\$185.56
2 X 1	\$191.00	\$227.22
2 X 1 1/2	\$131.22	\$156.11
2 1/2 X 1 1/2	\$171.56	\$229.33
2 1/2 X 2	\$147.56	\$202.22
3 X 1 1/2	\$193.33	\$294.44
3 X 2	\$188.89	\$255.56
3 x 2 1/2	\$167.11	\$244.44
4 X 2	\$305.56	\$412.00
4 x 2 1/2	\$300.00	\$333.33
4 x 3	\$244.78	\$326.67
6 x 3	\$844.44	\$933.33
6 x 4	\$888.89	\$944.44

SCHEDULE 5

E14WI-5 - SHORT MALE WELDING FERRULE

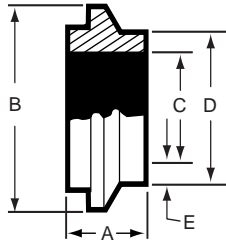

Size Tube OD	T304	T316L
1	N/A	\$57.78
1 1/2	N/A	\$57.78
2	N/A	\$108.89
2 1/2	N/A	\$115.56
3	N/A	\$122.22
4	N/A	\$335.56

E15WI-5 - SHORT FEMALE WELDING FERRULE

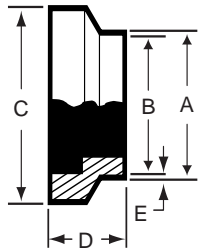

Size Tube OD	T304	T316L
1	N/A	\$57.78
1 1/2	N/A	\$57.78
2	N/A	\$108.89
2 1/2	N/A	\$115.56
3	N/A	\$122.22
4	N/A	\$335.56

E16AI-14I-5 - MALE END CAP

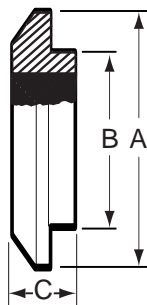

Size Tube OD	T304	T316L
1	POA	POA
1 1/2	POA	POA
2	POA	POA
2 1/2	POA	POA
3	POA	POA
4	POA	POA

E16AI-15I-5 - FEMALE END CAP

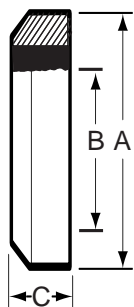

Size Tube OD	T304	T316L
1	POA	POA
1 1/2	POA	POA
2	POA	POA
2 1/2	POA	POA
3	POA	POA
4	POA	POA

SCHEDULE 5

E14WLI-5 - LONG MALE WELDING FERRULE

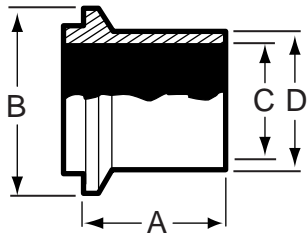

Size Tube OD	T304	T316L
1	POA	POA
1 1/2	POA	POA
2	POA	POA
2 1/2	POA	POA
3	POA	POA
4	POA	POA

E15WLI-5 - LONG FEMALE WELDING FERRULE

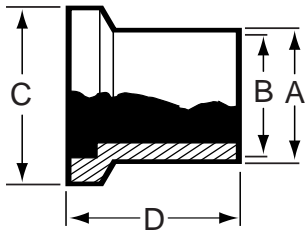

Size Tube OD	T304	T316L
1	POA	POA
1 1/2	POA	POA
2	POA	POA
2 1/2	POA	POA
3	POA	POA
4	POA	POA

E13IS-5 - HEAVY DUTY CLAMP

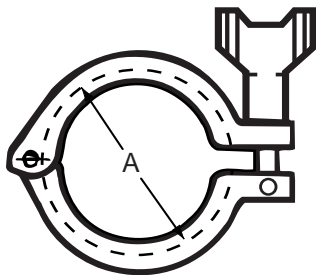

Size Tube OD	T304	T316L
1	\$17.91	N/A
1 1/2	\$20.18	N/A
2	\$31.31	N/A
2 1/2	\$32.76	N/A
3	POA	N/A
4	POA	N/A

E13IU-5 - CLAMP BOLTED

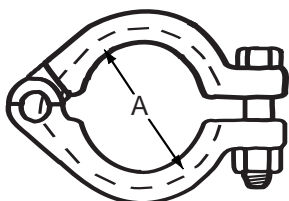

Size Tube OD	T304	T316L
1	\$14.51	POA
1 1/2	\$21.56	POA
2	\$27.64	POA
2 1/2	\$33.24	POA
3	\$66.67	POA
4	\$100.00	POA

EQ - LINE

E14WQ-6L

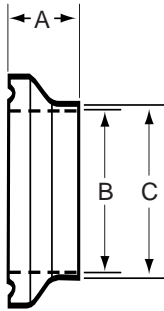

Size Tube OD	T304	T316L
1	N/A	\$28.22
1 1/2	N/A	\$34.33
2	N/A	\$43.00
2 1/2	N/A	\$100.44
3	N/A	\$111.11
4	N/A	\$179.22

E16AQ-14Q

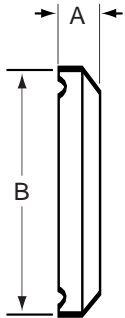

Size Tube OD	T304	T316L
1	N/A	\$32.22
1 1/2	N/A	\$32.22
2	N/A	\$46.56
2 1/2	N/A	\$77.78
3	N/A	\$92.22
4	N/A	\$104.44

FITTINGS



**Unpolished
Tube OD Fittings**



UNPOLISHED TUBE OD FITTINGS....

Unpolished Tube OD Weld Fittings are used in a wide variety of industrial applications where sanitary finishes are not generally required. VNE's tumbled finish presents a consistent uniform appearance.

VNE's Unpolished Weld Fittings are offered in nominal tube sizes 1/2" through 8" in T304 and T316L materials. Uniform wall thickness for 1/2" through 3" sizes measure .065 (16 ga). In 4" size, wall thickness measure .083 (14 ga), 6" and 8" .109 (12 ga).

TUBE OD FITTING SPECIFICATIONS....

Size Range: 1/2" OD through 8" OD

Materials: T304
T316L

Finish: Unpolished - Tumbled

ORDERING SPECIFICATIONS....

- Specify:**
- Quantity
 - Product description or Part No.
 - Size
 - Material Type
 - Polish Requirements

LIMITED WARRANTY....

VNE Corporation products are warranted to be free from defects in material and workmanship for a period of one year from the date of shipment. Any product that proves to be defective shall be repaired or replaced at the option of VNE, providing it has been used as recommended and in strict accordance with recognized piping practices, and that has not been subject to extraordinary service, such as encountered under severe corrosive or abrasive conditions.

VNE makes no warranties, express or implied, other than those listed above.

VNE shall not be liable for any consequential, indirect, incidental or contingent damages.

VNE CORPORATION

P.O. Box 1698 • 1149 Barberry Drive • Janesville, WI 53547

TEL: 608-756-4930 • FAX: 608-756-3643 • 1-800-356-1111 • Web site: vnestainless.com

UNPOLISHED TUBE OD FITTINGS

STAINLESS STEEL FITTINGS
PRICE BOOK

V2WC - 90° ELBOW LESS TANGENTS

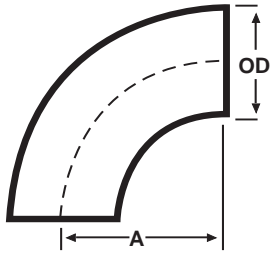

Size Tube OD	T304	T316L
1/2	\$12.56	\$15.60
3/4	\$12.56	\$15.60
1	\$8.42	\$11.02
1 1/4	\$33.11	\$42.22
1 1/2	\$8.89	\$11.20
2	\$11.00	\$13.90
2 1/2	\$20.00	\$24.36
3	\$21.78	\$28.90
4	\$43.31	\$54.60
6	\$222.22	\$266.67
8	\$435.56	\$508.89

V2S - 90° ELBOW WITH TANGENTS

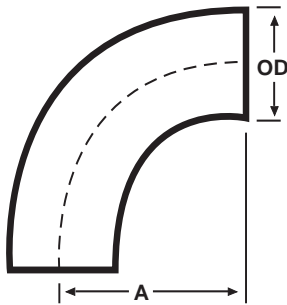

Size Tube OD	T304	T316L
1	\$15.00	\$24.33
1 1/2	\$15.00	\$24.33
2	\$18.33	\$29.89
2 1/2	\$26.89	\$43.67
3	\$41.78	\$68.22
4	\$72.67	\$116.44

V2WU - 180° U BEND

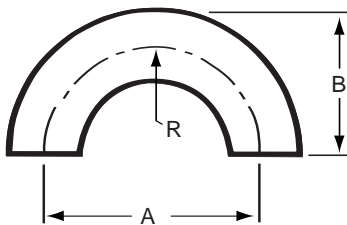

Size Tube OD	T304	T316L
1/2	N/A	\$44.44
3/4	N/A	\$44.44
1	\$46.78	\$52.89
1 1/4	POA	POA
1 1/2	\$53.89	\$62.67
2	\$59.11	\$83.33
2 1/2	\$80.89	\$103.33
3	\$98.44	\$194.44
4	\$153.33	\$250.00
6	\$366.67	POA

UNPOLISHED TUBE OD FITTINGS

STAINLESS STEEL FITTINGS
PRICE BOOK

V2WK - 45° ELBOW LESS TANGENTS

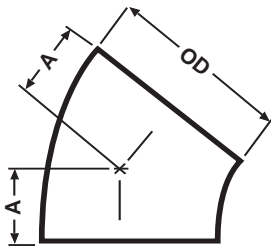

Size Tube OD	T304	T316L
1/2	\$12.56	\$15.60
3/4	\$12.56	\$15.60
1	\$10.44	\$7.71
1 1/4	\$37.78	\$77.78
1 1/2	\$10.44	\$11.20
2	\$10.89	\$13.91
2 1/2	\$17.33	\$22.67
3	\$19.60	\$22.75
4	\$41.74	\$54.60
6	\$180.00	\$237.00
8	\$280.00	\$344.60

V2KS - 45° ELBOW WITH TANGENTS

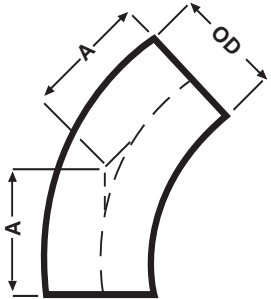

Size Tube OD	T304	T316L
1	\$15.11	\$24.44
1 1/2	\$15.11	\$24.44
2	\$17.78	\$28.67
2 1/2	\$23.33	\$37.89
3	\$29.31	\$47.00
4	\$54.66	\$84.44

V7W - LONG TEE

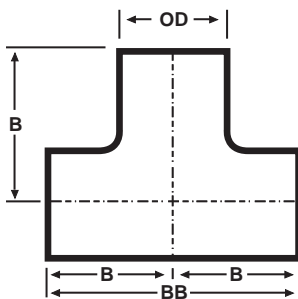

Size Tube OD	T304	T316L
1/2	\$28.56	\$55.56
3/4	\$32.22	\$55.56
1	\$15.56	\$17.47
1 1/4	\$44.44	POA
1 1/2	\$17.22	\$23.33
2	\$21.11	\$26.89
2 1/2	\$30.33	\$41.12
3	\$41.27	\$57.96
4	\$68.11	\$108.89
6	\$497.78	\$520.00
8	\$601.80	\$855.56

V7WWW - SHORT TEE

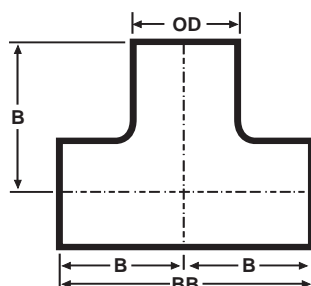

Size Tube OD	T304	T316L
1	\$27.11	\$38.33
1 1/2	\$25.00	\$38.33
2	\$28.67	\$43.78
2 1/2	\$41.56	\$58.11
3	\$59.67	\$91.33
4	\$90.33	\$136.67

UNPOLISHED TUBE OD FITTINGS

STAINLESS STEEL FITTINGS
PRICE BOOK

V7WR - REDUCING TEE

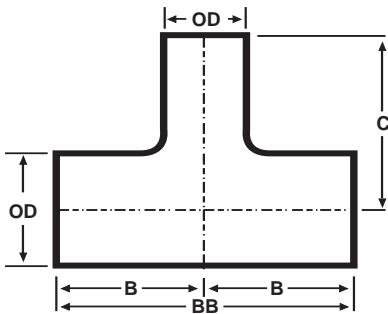

Size Tube OD	T304	T316L
3/4 X 1/2	N/A	\$58.22
1 X 1/2	N/A	\$58.22
1 X 3/4	N/A	\$66.67
1 1/2 X 1/2	N/A	\$61.36
1 1/2 X 3/4	N/A	\$51.70
1 1/2 X 1	\$23.67	\$30.70
1 1/2 X 1 1/4	\$87.78	POA
2 X 1	\$44.22	\$57.33
2 X 1 1/4	\$151.56	POA
2 X 1 1/2	\$27.50	\$38.40
2 1/2 X 1 1/2	\$63.11	\$85.11
2 1/2 X 2	\$43.02	\$69.82
3 X 1 1/2	\$73.00	\$97.50
3 X 2	\$60.26	\$97.50
3 X 2 1/2	\$60.26	\$97.50
4 X 2	\$75.10	\$101.00
4 X 2 1/2	\$75.10	\$101.00
4 X 3	\$75.10	\$101.00
6 X 2	\$464.44	\$531.11
6 X 3	\$375.56	\$531.11
6 X 4	\$375.56	\$305.00

V9W - CROSS

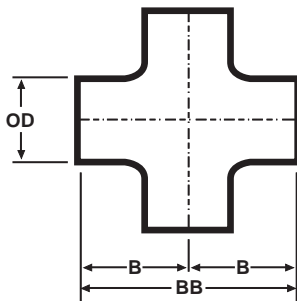

Size Tube OD	T304	T316L
1/2	N/A	\$102.00
3/4	N/A	\$102.00
1	\$52.78	\$57.44
1 1/4	POA	POA
1 1/2	\$57.89	\$72.78
2	\$72.33	\$92.89
2 1/2	\$153.33	\$163.33
3	\$153.33	\$257.78
4	\$242.22	\$328.89
6	\$911.11	\$1155.56

V14WA - TYPE A STUB END WITH GROOVES

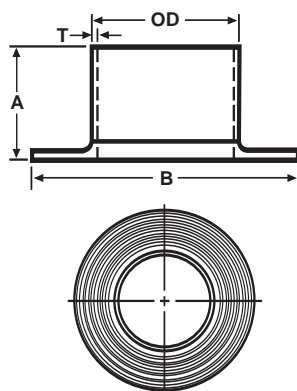

Size Tube OD	T304	T316L
1/2	N/A	\$77.78
3/4	N/A	\$84.44
1	N/A	\$71.00
1 1/4	N/A	POA
1 1/2	N/A	\$72.30
2	N/A	\$83.20
2 1/2	N/A	\$109.00
3	N/A	\$112.00
4	N/A	\$167.78
6	N/A	\$666.67

UNPOLISHED TUBE OD FITTINGS

STAINLESS STEEL FITTINGS
PRICE BOOK

F14WA - TYPE B STUB END LESS GROOVES

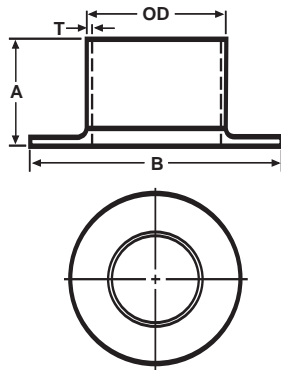

Size Tube OD	T304	T316L
1/2	POA	POA
3/4	POA	POA
1	POA	POA
1 1/4	POA	POA
1 1/2	POA	POA
2	POA	POA
2 1/2	POA	POA
3	POA	POA
4	POA	POA
6	POA	POA

V16W - WELD CAP

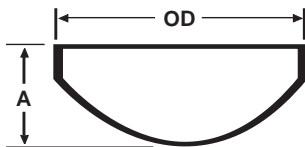

Size Tube OD	T304	T316L
1/2	N/A	\$34.44
3/4	N/A	\$34.44
1	\$9.56	\$16.20
1 1/4	\$13.78	\$28.89
1 1/2	\$10.89	\$16.80
2	\$14.11	\$17.20
2 1/2	\$17.78	\$19.40
3	\$20.22	\$20.44
4	\$26.67	\$28.70
6	\$186.67	\$202.22
8	\$333.33	\$466.67

19WB - MALE NPT X WELD ADAPTER

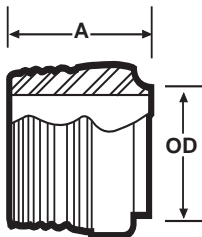

Size Tube OD	T304	T316L
1/2	N/A	\$17.50
3/4	N/A	\$17.50
1	\$10.35	\$17.03
1 1/4	N/A	\$65.56
1 1/2	\$14.40	\$24.91
2	\$21.02	\$34.06
2 1/2	\$37.91	\$59.00
3	\$48.98	\$67.27
4	\$98.42	\$118.00
6	\$311.11	\$466.67

22WB - FEMALE NPT X WELD ADAPTER

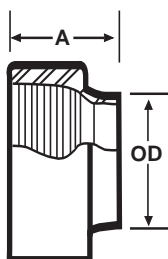

Size Tube OD	T304	T316L
1/2	N/A	\$46.67
3/4	N/A	\$46.67
1	\$25.33	\$32.33
1 1/4	N/A	\$57.22
1 1/2	\$27.78	\$39.00
2	\$30.00	\$42.33
2 1/2	\$52.33	\$69.22
3	\$66.11	\$81.78
4	\$99.89	\$135.00

UNPOLISHED TUBE OD FITTINGS

STAINLESS STEEL FITTINGS
PRICE BOOK

V28WA - 45° LATERAL

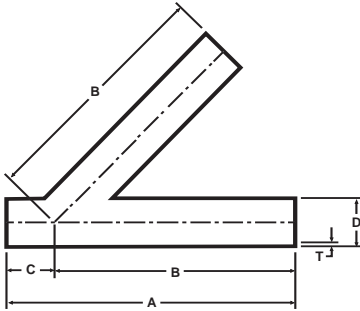

Size Tube OD	T304	T316L
1	\$137.56	\$177.78
1 1/2	\$177.78	\$186.67
2	\$183.33	\$196.67
2 1/2	\$238.89	\$257.78
3	\$266.67	\$316.67
4	\$320.00	\$350.00
6	\$777.78	\$1146.67

V28WB - TRUE Y

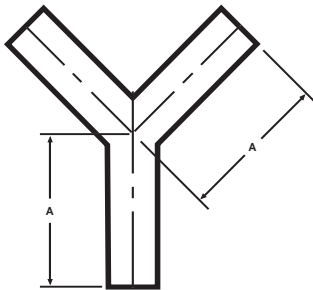

Size Tube OD	T304	T316L
1	\$146.67	\$138.89
1 1/2	\$150.00	\$177.78
2	\$183.33	\$196.67
2 1/2	\$238.89	\$257.78
3	\$266.67	\$316.67
4	\$294.44	\$350.00
6	\$1111.12	\$1288.89

V31W - CONCENTRIC REDUCER

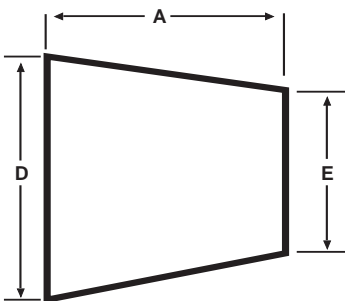

Size Tube OD	T304	T316L
3/4 X 1/2	N/A	\$44.51
1 X 1/2	N/A	\$93.33
1 X 3/4	N/A	\$40.00
1 1/2 X 1/2	N/A	\$97.13
1 1/2 X 3/4	N/A	\$97.13
1 1/2 X 1	\$12.96	\$16.40
1 1/2 X 1 1/4	\$70.00	\$73.34
2 X 1	\$24.20	\$36.90
2 X 1 1/4	\$73.33	\$77.78
2 X 1 1/2	\$14.60	\$18.70
2 1/2 X 1 1/2	\$32.22	\$36.44
2 1/2 X 2	\$17.44	\$20.80
3 X 1 1/2	\$50.27	\$74.91
3 X 2	\$23.56	\$31.00
3 X 2 1/2	\$22.89	\$28.20
4 X 2	\$72.53	\$82.89
4 X 2 1/2	\$66.22	\$82.89
4 X 3	\$24.30	\$40.00
6 X 3	\$282.22	\$300.00
6 X 4	\$282.22	\$300.00

UNPOLISHED TUBE OD FITTINGS

STAINLESS STEEL FITTINGS
PRICE BOOK

V32W - ECCENTRIC REDUCER

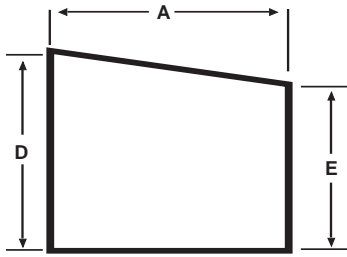

Size Tube OD	T304	T316L
3/4 X 1/2	N/A	\$64.00
1 X 1/2	N/A	\$64.00
1 X 3/4	N/A	\$64.00
1 1/2 X 1/2	N/A	\$99.71
1 1/2 X 3/4	N/A	\$99.71
1 1/2 X 1	\$23.70	\$31.56
1 1/2 x 1 1/4	POA	\$80.00
2 X 1	\$56.89	\$75.78
2 X 1 1/4	POA	POA
2 X 1 1/2	\$20.30	\$22.22
2 1/2 X 1 1/2	\$43.33	\$57.33
2 1/2 X 2	\$26.90	\$28.00
3 X 1 1/2	\$64.80	\$125.00
3 X 2	\$40.22	\$55.56
3 X 2 1/2	\$52.50	\$71.91
4 X 2	\$108.47	\$143.00
4 X 2 1/2	\$76.00	\$113.00
4 X 3	\$43.90	\$70.67
6 X 3	\$371.11	\$362.22
6 X 4	\$371.11	\$362.22

E38SL - SLIP ON FLANGE

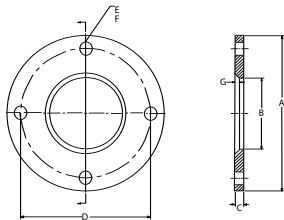

Size Tube OD	T304	T316L
1	\$96.67	N/A
1 1/2	\$93.33	N/A
2	\$102.22	N/A
2 1/2	\$130.56	N/A
3	\$155.56	N/A
4	\$185.56	N/A

V14RH - 6L B/W Rubber Hose Barb Blank #1

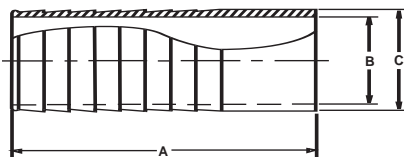

Size Tube OD	T304	T316L
1/4	N/A	\$37.48
5/16	N/A	\$37.48
3/8	N/A	\$18.11
1/2	N/A	\$18.11
5/8	N/A	\$28.41
3/4	N/A	\$28.41
1	N/A	\$23.70
1 1/4	N/A	\$23.70
1 1/2	N/A	\$23.70
2	N/A	\$25.80
2 1/2	N/A	\$25.80
3	N/A	\$28.00
4	N/A	\$47.12
6	N/A	\$137.12



European Din Connections....

VNE's European Din Connections are available in Inch-Size Tube O.D. Weld Neck. Now inch size tubing can be utilized on projects requiring Din Connections, where in the past metric tubing had to be purchased.

VNE stocks welding ferrules - both male (threaded) and female (plain) - along with the standard DIN nut and gasket to complete the union in T304. T316 ferrules are available upon request.

EUROPEAN DIN SPECIFICATIONS....

Product: Din Connection x Din Weld Connection
Fully Metric Din Fittings

Size Range: Din 10 - Din 100

Materials: T304 & T316

Finish: #7 ID / OD Polish

ORDERING SPECIFICATIONS....

25-KURZ-NW10
(Din male threaded ferrule size 10, T304)

35-KURZ-6-NW10
(Din female plain ferrule size 10, T316)

EUROPEAN DIN SPECIFICATIONS....

Product: Din Connection X Inch Weld
Connection

Size Range: 1" - 4"

Materials: T304 & T316

Finish: #7 ID / OD Polish

ORDERING SPECIFICATIONS....

2SRW-25 X 1.0
(Din male threaded ferrule x size 1" weld connection, T304)

3SRW-6-25X1.0
(Din female plain ferrule x size 1" weld connection, T316)

VNE CORPORATION

P.O. Box 1698 • 1149 Barberry Drive • Janesville, WI 53547

TEL: 608-756-4930 • FAX: 608-756-3643 • 1-800-356-1111 • Web site: vnestainless.com

4-NUT-NW-(SIZE) (304 ONLY)

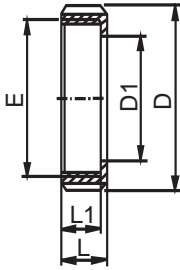

Size (Din)	T304	T316
10	\$30.00	N/A
15	\$32.89	N/A
20	\$33.12	N/A
25	\$33.78	N/A
32	\$34.23	N/A
40	\$37.78	N/A
50	\$41.12	N/A
65	\$60.00	N/A
75/3	\$103.56	N/A
80	\$111.12	N/A
100	\$133.34	N/A
125	\$173.34	N/A
150	\$493.34	N/A
200	\$666.67	N/A

5-RING NW (SIZE) BUNA

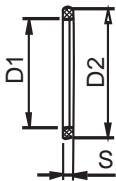

Size (Din)	T304	T316
10	\$5.00	N/A
15	\$5.23	N/A
20	\$5.56	N/A
25	\$6.23	N/A
32	\$6.45	N/A
40	\$6.89	N/A
50	\$7.78	N/A
65	\$10.45	N/A
75/3	\$12.23	N/A
80	\$12.89	N/A
100	\$16.67	N/A
125	\$21.12	N/A
150	\$21.12	N/A

5A-RING NW (SIZE) EPDM

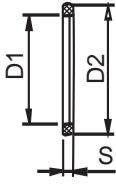

Size (Din)	T304	T316
10	\$5.00	N/A
15	\$5.23	N/A
20	\$5.56	N/A
25	\$6.23	N/A
32	\$6.45	N/A
40	\$6.89	N/A
50	\$7.78	N/A
65	\$10.45	N/A
75/3	\$12.23	N/A
80	\$12.89	N/A
100	\$16.67	N/A
125	\$21.12	N/A
150	\$21.12	N/A

5B- RING NW (SIZE) SILICONE

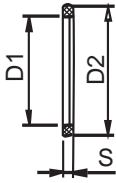

Size (Din)	T304	T316
10	\$5.00	N/A
15	\$5.23	N/A
20	\$5.56	N/A
25	\$6.23	N/A
32	\$6.45	N/A
40	\$6.89	N/A
50	\$7.78	N/A
65	\$10.45	N/A
75/3	\$12.23	N/A
80	\$12.89	N/A
100	\$16.67	N/A
125	\$21.12	N/A
150	\$21.12	N/A

2S-KURZ-NW(SIZE) DIN MALE THREAD X DIN WELD FERRULE T304 / T316

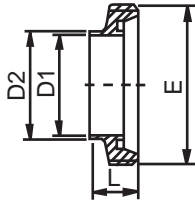

Size (Din)	T304	T316
10	\$24.67	\$28.89
15	\$27.56	\$31.12
20	\$34.00	\$37.78
25	\$35.56	\$41.12
32	\$39.34	\$43.89
40	\$40.45	\$48.89
50	\$43.89	\$52.23
65	\$50.45	\$55.56
80	\$86.23	\$97.78
100	\$127.78	\$144.45
125	\$222.23	\$266.67
150	\$320.00	\$388.89

3S-KURZ-NW(SIZE) DIN FEMALE X DIN WELD FERRULE T304 / T316

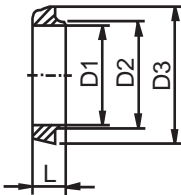

Size (Din)	T304	T316
10	\$16.45	\$20.56
15	\$18.23	\$23.34
20	\$23.12	\$24.45
25	\$24.45	\$27.78
32	\$26.23	\$28.89
40	\$27.78	\$31.67
50	\$28.89	\$37.23
65	\$36.89	\$41.12
80	\$64.23	\$72.23
100	\$98.23	\$111.12
125	\$146.67	\$222.23
150	\$422.23	\$295.56

74-CAP NW(SIZE) (304 & 316)

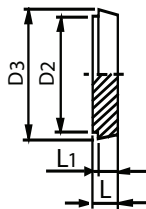

Size (Din)	T304	T316
10	\$18.67	\$34.23
15	\$20.00	\$36.00
20	\$24.45	\$38.00
25	\$28.89	\$48.89
32	\$37.12	\$60.00
40	\$42.00	\$71.12
50	\$59.78	\$80.00
65	\$67.78	\$96.00
80	\$98.23	\$113.34
100	\$164.00	\$197.78
125	\$266.67	\$420.00
150	\$377.78	\$500.00

2SRW (SIZE) DIN MALE THREAD X INCH WELD FERRULES T304 / T316

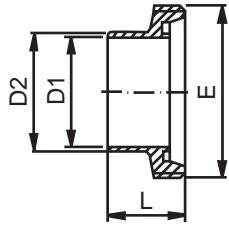

Size (Din)	T304	T316
25 X 1.0	\$25.23	\$36.67
40 X 1.5	\$30.67	\$44.45
50 X 2.0	\$34.67	\$47.78
65 X 2.5	\$52.89	\$77.78
75 X 3.0	\$79.67	\$113.34
80 X 3.0	N/A	\$377.22
100 X 4.0	\$130.00	\$188.89

3SRW (SIZE) DIN FEMALE X INCH WELD FERRULES T304 / T316

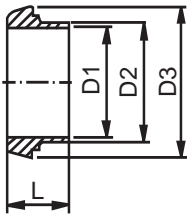

Size (Din)	T304	T316
25 X 1.0	\$17.12	\$23.78
40 X 1.5	\$20.89	\$28.67
50 X 2.0	\$24.45	\$33.34
65 X 2.5	\$39.78	\$55.56
75 X 3.0	\$68.89	\$100.00
80 X 3.0	N/A	\$272.44
100 X 4.0	\$93.89	\$133.34



Pipe Hangers....

Pipe Hangers are available in Tube OD sizes. All hangers are hexagonal shape with either rubber grommets or PVC inserts. Hangers are also available with a 3/8" coupling.

Larger tube OD and pipe sizes are available upon special request.

PIPE HANGER SPECIFICATIONS....

Product: Tube OD Piping Hangers

Size Range: 1/2" through 6" sizes

Materials: T304 - Hangers
Rubber / Viton - Grommets
PVC - Sleeve insert

ORDERING SPECIFICATIONS....

Specify:

- Quantity
- Product description or Part No.
- Size
- Material Type

VNE CORPORATION

P.O. Box 1698 • 1149 Barberry Drive • Janesville, WI 53547

TEL: 608-756-4930 • FAX: 608-756-3643 • 1-800-356-1111 • Web site: vnestainless.com

PIPE HANGERS

E24

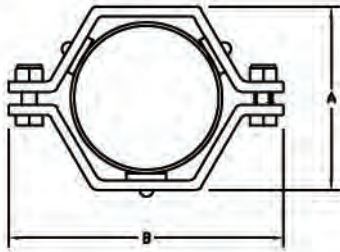

Size Tube OD	T304	T316
1/2	\$11.74	N/A
3/4	\$11.74	N/A
1	\$10.67	N/A
1 1/2	\$11.41	N/A
2	\$12.60	N/A
2 1/2	\$14.23	N/A
3	\$16.30	N/A
4	\$20.60	N/A
6	\$45.63	N/A

E24C

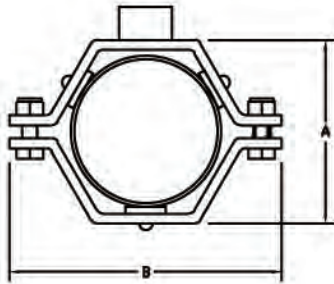

Size Tube OD	T304	T316
1/2	\$20.75	N/A
3/4	\$20.80	N/A
1	\$20.89	N/A
1 1/2	\$21.00	N/A
2	\$21.30	N/A
2 1/2	\$23.44	N/A
3	\$23.60	N/A
4	\$29.52	N/A
6	\$47.89	N/A

E24PVC

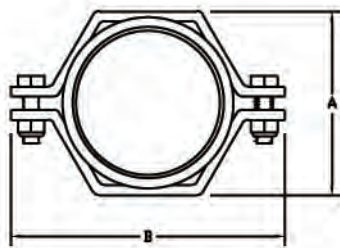

Size Tube OD	T304	T316
1/2	\$9.63	N/A
3/4	\$12.15	N/A
1	\$12.20	N/A
1 1/2	\$12.30	N/A
2	\$12.60	N/A
2 1/2	\$14.38	N/A
3	\$16.60	N/A
4	\$20.89	N/A
6	\$60.39	N/A